

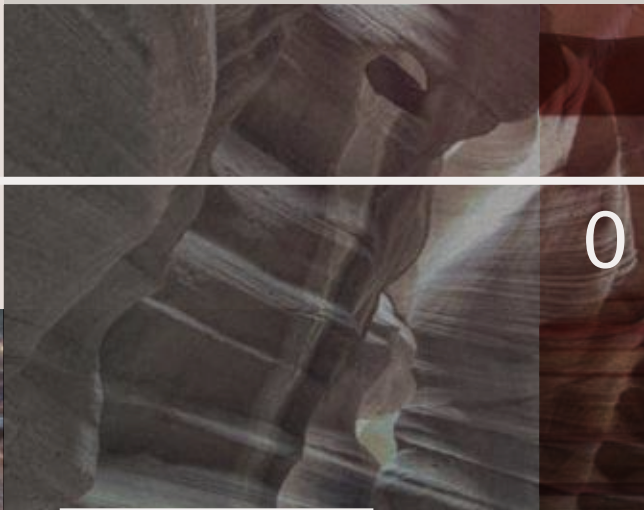

2

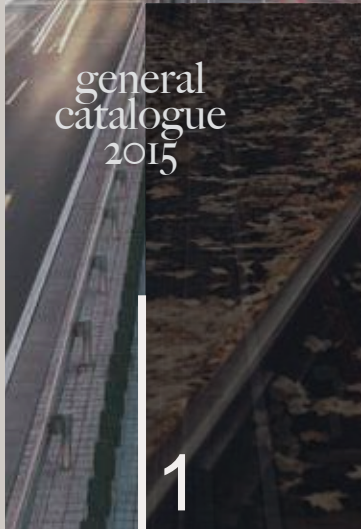

0

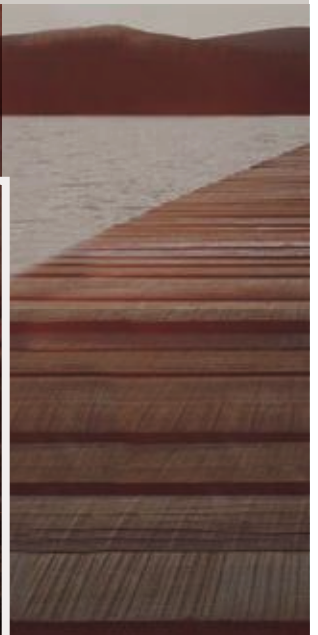

general
catalogue
2015

1



exagres
by versatile
NATURAL ESSENCE

5

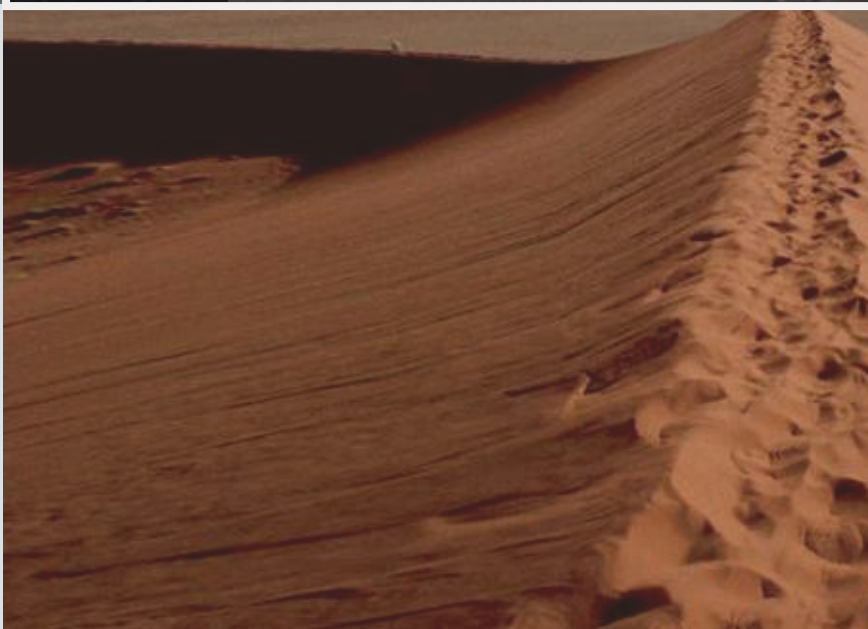

A faded, sepia-toned photograph of a forested hillside overlooking a body of water. The image is very light and lacks detail, appearing as a soft, hazy background. The text 'www.versatile.es' is centered in the middle of the image.

www.versatile.es



EXAGRES nació en 1976 en Betxí, Castellón.

En la actualidad contamos con unas instalaciones de 80.000m2 con plantas de producción de última generación.

Desde nuestros inicios hemos trabajado con un gran equipo de profesionales, apoyado en todo momento por la tecnología más avanzada, con el objetivo de ofrecer productos de la más alta calidad, que se adapten perfectamente a las tendencias del mercado.

En EXAGRES apostamos por la innovación y mejora continua en todos los ámbitos de nuestra empresa, para ofrecer el mejor servicio del mejor producto.

La satisfacción de nuestros clientes constituye nuestra principal prioridad. La Calidad Total se garantiza con el continuo control de calidad interno y mediante ensayos y análisis realizados en laboratorios independientes homologados internacionalmente.

EXAGRES, empresa ubicada en un entorno privilegiado, es consciente de su responsabilidad con el Medio Ambiente. Las instalaciones de EXAGRES cuentan con un avanzado proceso de depuración de residuos que elimina vertidos contaminantes y con un sistema de cogeneración de energía eléctrica que permite el ahorro energético. EXAGRES, ha obtenido la Certificación de su Sistema de Gestión Medioambiental conforme a ISO 14001-2004.

El Sistema de Calidad de Exagres, asegura la calidad de sus procesos y productos, en todas las fases: diseño, desarrollo, producción y comercialización y cuenta con la Certificación ISO 9001-2008.

EXAGRES was founded in Betxí, Castellón, in 1976.

Nowadays owns a 80.000m2 premises with last generation production plants.

Right from the beginning we have been working with a great team of professionals, supported at all times by the very latest technology, in order to be able to offer products of the highest quality that adapt perfectly to market trends.

At EXAGRES we aim for innovation and constant improvement in all spheres within the company to make sure that we provide an excellent service and an excellent product.

Customer satisfaction is our top priority. Continuous internal quality control and certified international laboratories test and analyses provide Total Quality, guaranteed by EXAGRES by a strict quality control fulfilling all established norms for each product from range.

EXAGRES located in a privileged landscape, in aware of its responsibility with the environment. EXAGRES has an advanced water treatment plant that removes polluted leftovers and also an electric cogeneration system that permits energy savings. Environmental Management Systems by EXAGRES, is Certified according (ISO 14001-2004.)

EXAGRES Quality System guarantees all its processes and product range, in all its phases: Design, Development, Production and Commercialization, certified (ISO 9001-2008.)

EXAGRES a été fondée à Betxí, Castellón, en 1976..

Aujourd'hui propriétaire de plus de 80.000 m2 de locaux avec usine de production de dernière génération.

Dès le début nous avons travaillé avec une grande équipe de professionnels, soutenue à tous les niveaux par les technologies les plus récentes, afin d'être en mesure d'offrir des produits de la plus haute qualité qui s'adaptent parfaitement aux tendances du marché.

Chez Exagres nous visons l'innovation et l'amélioration constante dans tous les domaines au sein de l'entreprise pour assurer que nous offrons un excellent service et un produit d'excellence.

La satisfaction de nos clients est notre priorité absolue.

La Qualité Totale est garantie par le contrôle continu de la qualité par de tests internes et certifiés, ainsi que par des essais et analyse réalisés par des laboratoires indépendants homologués internationalement sur chaque produit de la gamme.

EXAGRES, située dans un cadre privilégié, est consciente de sa responsabilité envers l'environnement. Exagres dispose d'un système de dépuración de déchets très avancé qui permet d'éliminer les déchets polluants. Nous disposons également d'un système de co-génération d'énergie électrique qui nous permet d'économiser de l'énergie. EXAGRES a obtenu la Certification de son Système de Gestion Environnementale selon ISO 14001-2004.

Le Système de Qualité d'Exagres garantit la qualité de ses processus et produits lors de toutes les étapes : dessin, développement, production, commercialisation. Exagres a reçu aussi la Certification ISO 9001-2008.

Фабрика EXAGRES создана в 1976 в Бечи, Кастильон, Испания.

В настоящее время фабрика занимает площадь 80.000 кв. м. На фабрике используется оборудование последнего поколения.

С самого начала мы работаем с лучшими специалистами и всегда при поддержке самой современной технологии, чтобы обеспечить наших клиентов продукцией высокого качества, соответствующей тенденциям рынка.

На нашем предприятии мы делаем ставку на инновации и постоянное совершенствование во всех сферах с целью предложить лучший сервис и качество.

Наше кредо – удовлетворить потребности наших потребителей.

Постоянный внутренний контроль качества, а также испытания и анализы, сделанные в независимых лабораториях по международным стандартам, гарантируют качество нашей продукции. Наша фабрика находится в живописной зоне и мы отдаем себе отчет в том, что не должны наносить вред окружающей среде. На оборудовании Эксагрес используется усовершенствованная система очищения осадков, которая удаляет загрязняющие отходы, а также имеет систему когенерации энергии, которая экономит энергетические ресурсы. Система Экологического Контроля Эксагрес прошла сертификацию в соответствии с ISO 14001-2004.

Система контроля качества Эксагрес обеспечивает качество процессов и продукции на любой стадии: дизайн, разработка, производство и продажа.

Exagres имеет сертификат ISO 9001-2008.

exagres
by versatile

NATURAL ESSENCE



Study nature,
love nature,
stay close to nature.
It will never fail you.



INDICE
INDEX

	collections	pages
p.04-17	<p>WOOD ESSENCE</p>	<p>NATURA — 06-13 TAIGA — 14-17</p>
p.18-33	<p>EARTH ESSENCE</p>	<p>ALHAMAR — 20-29 COTO TOSCANO — 30-33</p>
p.34-49	<p>STONE ESSENCE</p>	<p>ATLAS — 36-39 PETRA — 40-45 VEGA — 46-49</p>
p.50-63	<p>URBAN ESSENCE</p>	<p>LEGEND — 52-55 MEDITERRÁNEO — 56-59 PROJECTKER — 60-63</p>
p.64-77	<p>METAL ESSENCE</p>	<p>METÁLICA — 66-69 ÓXIDO — 70-73 SILEX — 72-75</p>
p.78-85	<p>JEWEL ESSENCE</p>	<p>ART — 80-85</p>
p.86-87	CARACTERÍSTICAS TÉCNICAS - TECHNICAL DATA	
p.88-89	EMBALAJE - PACKING	
p.90-92	PIEZAS ESPECIALES - SPECIAL PIECES	
p.93	RECOMENDACIONES DE LIMPIEZA - CLEANING SUGGESTIONS	
p.94-95	RECOMENDACIONES DE COLOCACIÓN - INSTALLATION SUGGESTIONS	
p.96	ÍNDICE POR FORMATOS - FORMATS INDEX	

NATURA
collection

SIZES
16,25x66,5 cm

COLOURS
KENIA
ETNA
CRETA

TAIGA
collection

SIZES
33x66,5 cm
16,25x66,5 cm

COLOURS
ABEDUL
PINO
CEREZO
ÉBANO

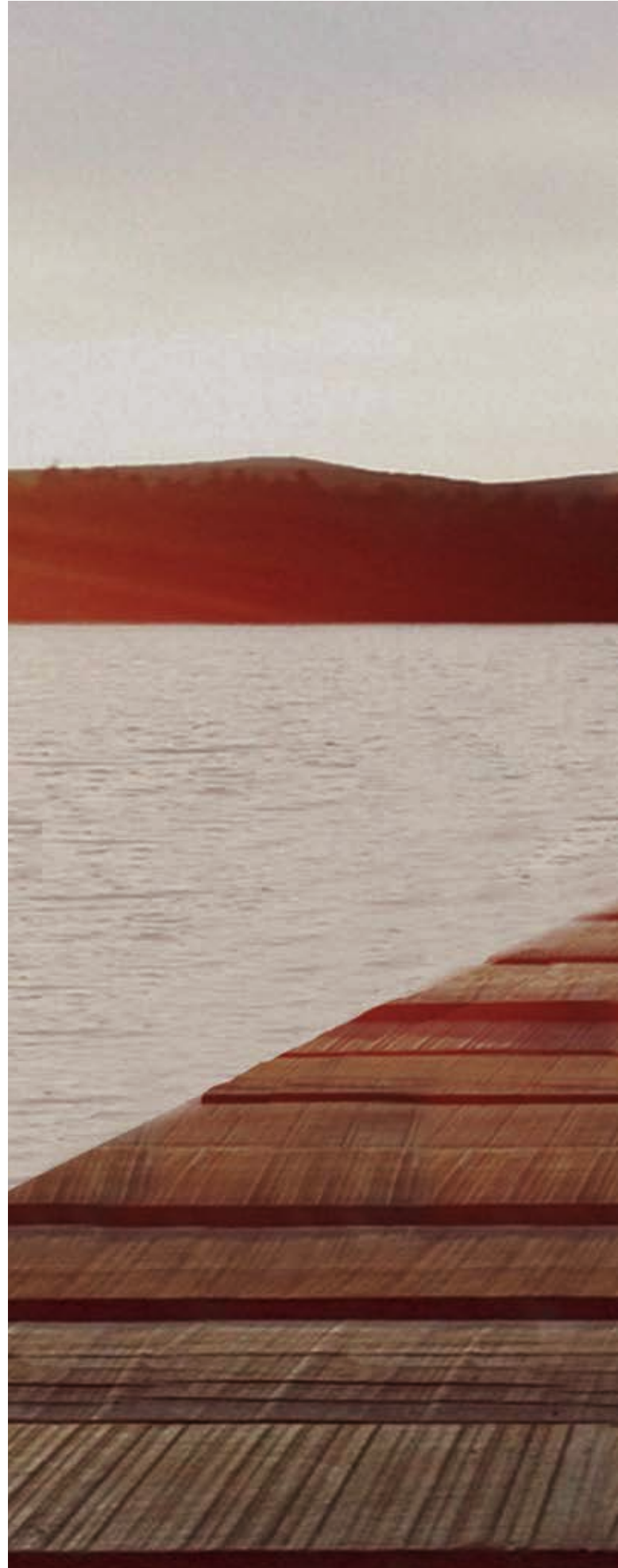



W

O

p.04/17

WOOD
ESSENCE

O

D

exagres
by versatile

NATURA
collection

Natura Creta
16,25x66,5 cm -
Borde Piscina -
Ángulo Interior







NATURA
collection

Natura Kenia
16,25x66,5 cm -
Peldaño Fiorentino
33x33x3 cm







NATURA
collection

Natura Etna
16,25x66,5 cm







KENIA

16,25 x 66,5 cm -
6.4 x 26.2"



ETNA

16,25 x 66,5 cm -
6.4 x 26.2"



CRETA

16,25 x 66,5 cm -
6.4 x 26.2"



Note Kenia*
16,25 x 66,5 cm - 6.4 x 26.2"



*1 set 3 piezas - 3 pieces pack



CLASE 3 R10

Acabado antideslizante **Clase 3** (según C.T.E.). /
Antislip C Class. / Finition antidérapante C Classe.
/ В наличии с покрытием анти-слип.



Suaves relieves y destonificados / Smooth relieves and slight
change of tones / Douces nuances de ton. Relief doux /
Гладкая поверхность и расхождение в оттенке



Borde Piscina
28 x 66,5 cm - 11.0"x 26.2"



Ángulo Interior Piscina
33 x 33 cm - 13.2"x 13.2"



Ángulo Exterior Piscina
28 x 28 cm - 11.0"x 11.0"

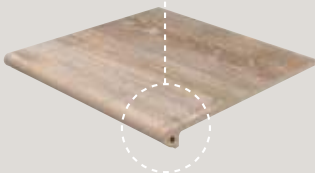

Peldaño Fiorentino
33 x 33 x 3 cm - 13.2 x 13.2"x 1.2"

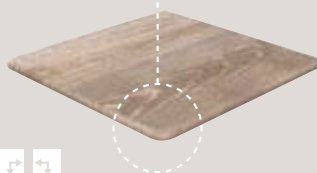

Cartabón Fiorentino **dcha./izda**
33 x 33 x 3 cm - 13.2"x 13.2"x 1.2"



Zanquín Fiorentino **dcha./izda**.
39,5 x 17,5 cm - 15.8"x 7"

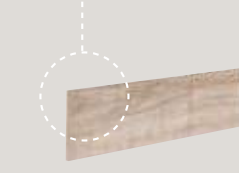

Rodapié
9 x 33 cm - 3.6"x 13.2"

NATURA
collection

KLINKER EXTRUSIONADO_EXTRUDED KLINKER

Gres extrusionado de pasta blanca, esmaltado en monococción.
Extruded ceramic with white body, glazed in a single firing.
Grès étirée de pâte blanche, et un émaillée produit avec une seule cuisson.
Вся серия NATURA произведена путём экструзии из белой глины. Плитка глазурованная,
одинарного обжига.



R10



CLASE 3



<1.5%



CLASS 5



10 mm

Dorso estriado en cola de milano / Dove tail profile /
Façonnage en queue d'aronde au dos des carreaux /
«Ласточкин хвост» на задней стороне плитк

Junta recomendada 5 mm / Recommended joint between
pieces 5mm / 5 mm de jointe entre chaque pièce à la mise/
с 5 мм между плитками





Note Etna*
16,25 x 66,5 cm - 6.4 x 26.2"

*1 set 3 piezas - 3 pieces pack

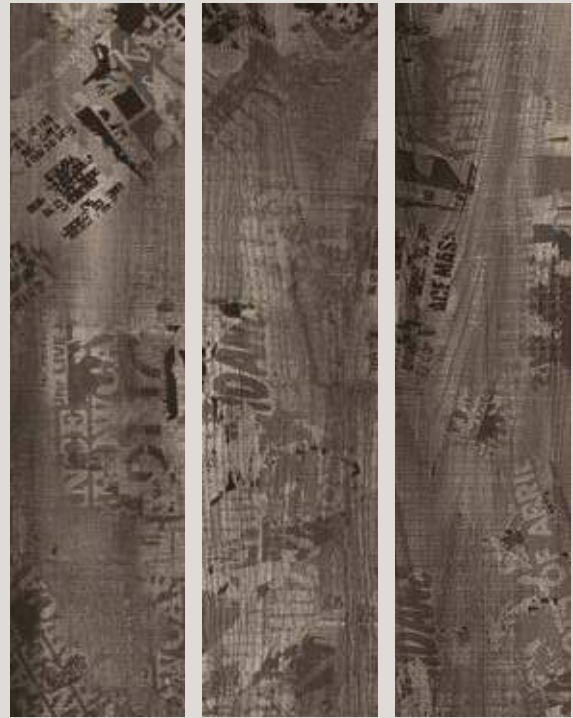

Note Creta*
16,25 x 66,5 cm - 6.4 x 26.2"

*1 set 3 piezas - 3 pieces pack



Chromatic**
16,25 x 66,5 cm - 6.4 x 26.2"

**1 set 6 piezas - 6 pieces pack

TAIGA
collection

Taiga Ébano
33x66.5 cm







ABEDUL

33 x 66,5 cm - 13.2"x 26.6"
 16,25x66,5cm-6.4"x26.6"



PINO

33 x 66,5 cm - 13.2"x 26.6"
 16,25x66,5cm-6.4"x26.6"



CEREZO

33 x 66,5 cm - 13.2"x 26.6"
 16,25x66,5cm-6.4"x26.6"



ÉBANO

33 x 66,5 cm - 13.2"x 26.6"
 16,25x66,5cm-6.4"x26.6"

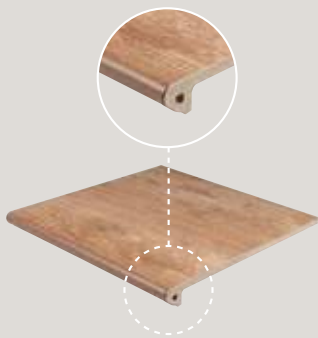

Peldaño Fiorentino
 33 x 33 x 3 cm - 13.2 x 13.2"x 1.2"

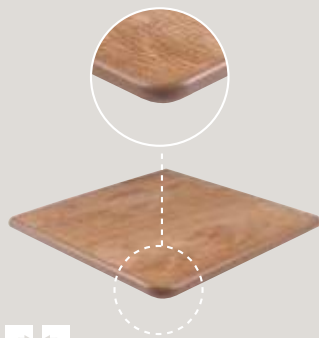

Cartabón Fiorentino **dcha./izda**
 33 x 33 x 3 cm - 13.2"x 13.2"x 1.2"

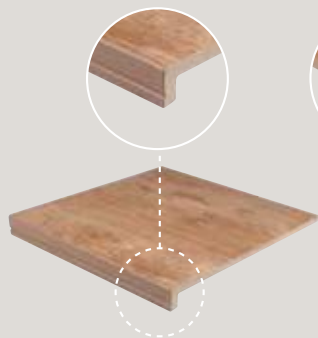

Peldaño Recto
 33 x 33 x 3 cm - 13.2"x 13.2"x 1.2"

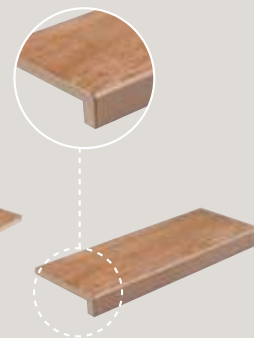

Vierteaguas
 12 x 33 x 3 cm - 4.7"x 13.2" x 1.2"



Rodapié
 9 x 33 cm - 3.6"x 13.2"



Zanquín Fiorentino **dcha./izda**
 39,5 x 17,5 cm - 15.8"x 7"



Zanquín Recto **dcha./izda**
 42,3 x 17,5 cm - 16.92"x 7"



Listelo
 3 x 66,5 cm - 1.2"x 26.6"

KLINKER EXTRUSIONADO_EXTRUDED KLINKER

Gres extrusionado de pasta blanca, esmaltado en monococción.
 Extruded ceramic with white body, glazed in a single firing.
 Grès étirée de pâte blanche, et un émaillée produit avec une seule cuisson.
 Вся серия TAIGA произведена путём экструзии из белой глины. Плитка глазурованная, одинарного обжига.



R9 CLASE 1 <1,5% CLASS 5 2 SIZES 10 mm

Dorso estriado en cola de milano / Dove tail profile /
 Façonnage en queue d'aronde au dos des carreaux /
 «Ласточкин хвост» на задней стороне плитк

Junta recomendada 5 mm / Recommended joint between
 pieces 5mm / 5 mm de jointe entre chaque pièce à la mise/
 с 5 мм между плитками



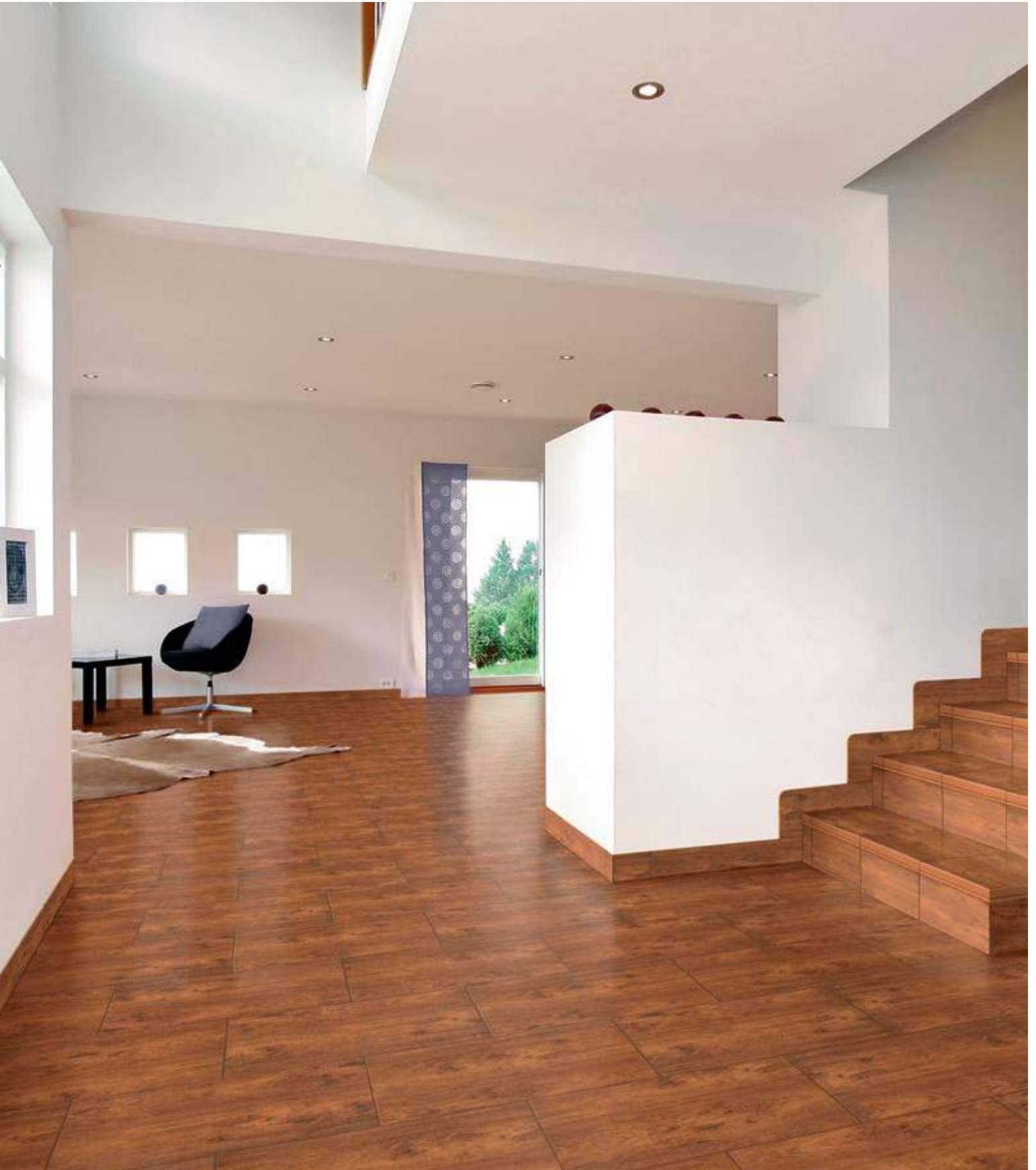

ALHAMAR
collection

SIZES

33x33 cm
16,25x33 cm
16,25x16,25 cm

COLOURS

BLANCO
PAJA
SALMÓN
ROJO

COTO
TOSCANO
collection

SIZES

24,5x24,5 cm
12x24,5 cm

COLOURS

COTO TOSCANO

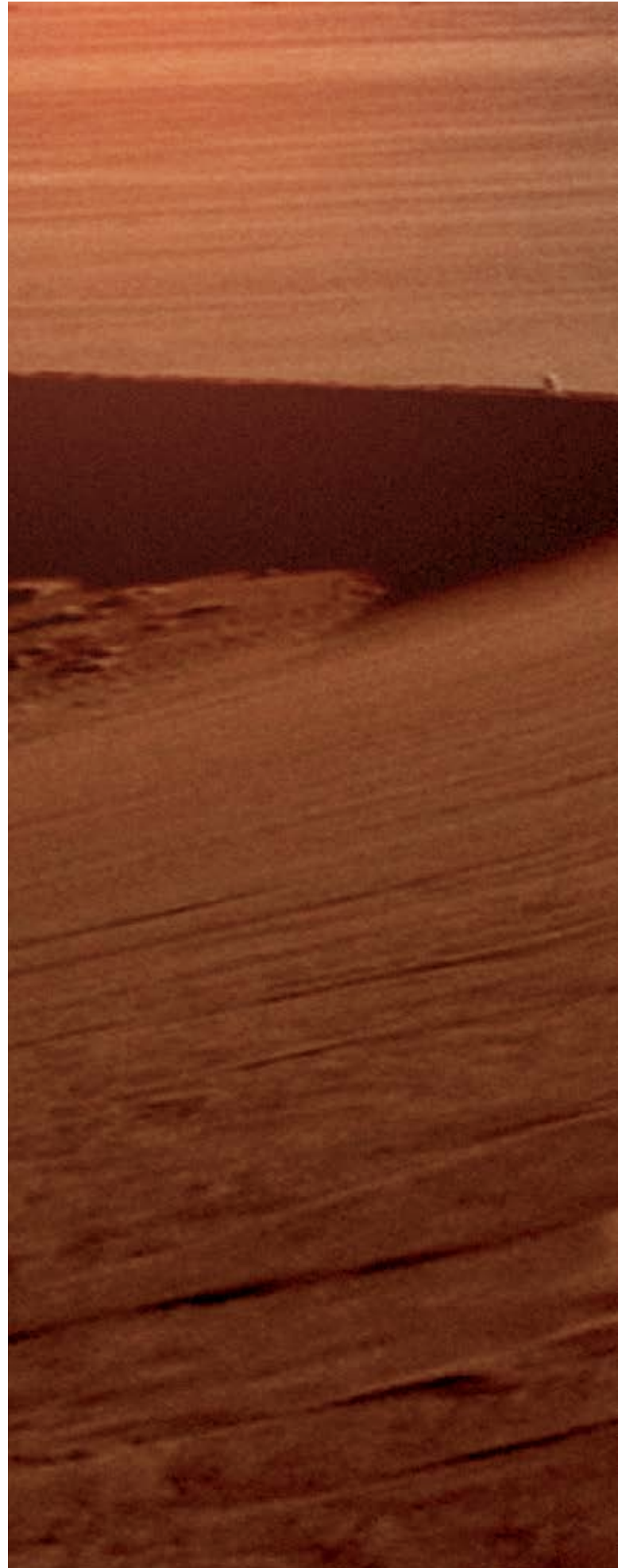



E

A

p.18/33

EARTH
ESSENCE

R

TH

exagres
by versatile

ALHAMAR
collection

Alhamar Salmón
33x33 cm -
Decorative
Salmón 33x33 cm





ALHAMAR
collection

Alhamar Blanco
33x33 cm





ALHAMAR
collection

Alhamar Rojo
33x33 cm -
Decorative
Rojo 33x33 cm -
Rodapié 9x33 cm -
Peldaño Fiorentino
33x33 x3 cm -
Zanquin Fiorentino







BLANCO



33 x 33 cm - 13.2"x 13.2"



16,25 x 33 cm - 6.4"x 13.2"



16,25 x 16,25 cm - 6.4"x 6.4"



PAJA



33 x 33 cm - 13.2"x 13.2"



16,25 x 33 cm - 6.4"x 13.2"



16,25 x 16,25 cm - 6.4"x 6.4"



SALMÓN



33 x 33 cm - 13.2"x 13.2"



16,25 x 33 cm - 6.4"x 13.2"



16,25 x 16,25 cm - 6.4"x 6.4"



ROJO



33 x 33 cm - 13.2"x 13.2"



16,25 x 33 cm - 6.4"x 13.2"



16,25 x 16,25 cm - 6.4"x 6.4"



CLASE 2

Acabado antideslizante
Clase 2 (según C.T.E.) /
Antislip C Class. /
Finition antidérapante C
Classe. /



R9

В наличии с покрытием
анти-слип.



Suaves relieves y
destonificados / Smooth
relievs and slight change
of tones /
Douce nuances
de ton. Relief doux /
Гладкая поверхность и
расхождение в оттенке.

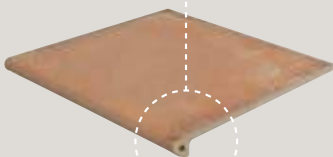

Peldaño Fiorentino

33 x 33 x 3 cm - 9.6" x 13.2" x 1.2"

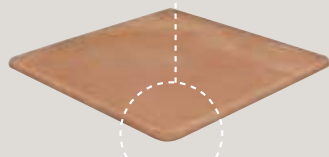

Cartabón Fiorentino

33 x 33 x 3 cm - 13.2" x 13.2" x 1.2"



Zanquín Fiorentino dcha./izda.

39,5 x 17,5 cm - 15.8" x 7"

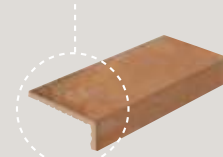

Vierteaguas

15 x 33 x 4 cm - 5.9" x 13.2" x 1.6"



Rodapié

9 x 33 cm - 3.6" x 13.2"

ALHAMAR
collection

KLINKER EXTRUSIONADO_EXTRUDED KLINKER

Gres extrusionado de pasta blanca, esmaltado en monococción.
Extruded ceramic with white body, glazed in a single firing.
Grès étirée de pâte blanche, et un émaillée produit avec une seule cuisson.
Вся серия ALHAMAR произведена путём экструзии из белой глины. Плитка глазурованная, одинарного обжига.



R9



CLASE 2



<1.5%



CLASS 5



3 SIZES



10 mm

Cantos biselados / Beveled edge / Arêtes biseaulées /

Скосенная кромка

Dorso estriado en cola de milano / Dove tail profile /

Faconnage en queue d'aronde au dos des carreaux /

«Ласточкин хвост» на задней стороне плитк

Junta recomendada 5 mm / Recommended joint between pieces
5mm / 5 mm de jointe entre chaque pièce a la mise /

с 5 мм между плитками





Decorative Blanco
33 x 33 cm - 13.2" x 13.2"

Decorative Paja
33 x 33 cm - 13.2" x 13.2"

Decorative Salmón
33 x 33 cm - 13.2" x 13.2"

Decorative Rojo
33 x 33 cm - 13.2" x 13.2"

*1 set 4 piezas - 4 pieces pack



Listelo Natura
3,8 x 33 cm - 1.50"x 13.2"



Taco Natura
3,8 x 3,8 cm - 1.50"x 1.50"



Clay Blanco
33 x 33 cm - 13.2" x 13.2"

Clay Paja
33 x 33 cm - 13.2" x 13.2"

Clay Salmón
33 x 33 cm - 13.2" x 13.2"

Clay Rojo
33 x 33 cm - 13.2" x 13.2"

*1 set 2 piezas - 2 pieces pack



Tabica Clay Blanco
15 x 33 cm - 5.90" x 13.2"

Tabica Clay Paja
15 x 33 cm - 5.90" x 13.2"

Tabica Clay Salmón
15 x 33 cm - 5.90" x 13.2"

Tabica Clay Rojo
15 x 33 cm - 5.90" x 13.2"

*1 set 2 piezas - 2 pieces pack

KLINKER EXTRUSIONADO_EXTRUDED KLINKER

Gres extrusionado de pasta blanca, esmaltado en monococción.
Extruded ceramic with white body, glazed in a single firing.
Grès étirée de pâte blanche, et un émaillée produit avec une seule cuisson.
Вся серия ALHAMAR произведена путём экструзии из белой глины. Плитка глазурованная, одинарного обжига.



Cantos biselados / Beveled edge / Arêtes biseaulées /

Скошенная кромка

Dorso estriado en cola de milano / Dove tail profile /

Façonnage en queue d'aronde au dos des barreaux /

«Ласточкин хвост» на задней стороне плитк

Junta recomendada 5 mm / Recommended joint between pieces
5mm / 5 mm de jointe entre chaque pièce a la mise /
с 5 мм между плитками





COTO
TOSCANO
collection

Coto Toscano
24,5x24,5x3 cm -
12x24,5 cm -
Peldaño Florentino
24,5x33 cm -
Vierteaguas
12x24,5x5 cm -
Rodapié
9x24,5 cm





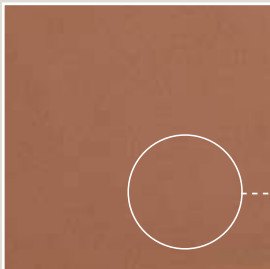

COTO TOSCANO



24,5 x 24,5 cm - 9.6"x 9.6"



12 x 24,5 cm - 4.7"x 9.6"



detalle textura - texture detail

Acabado antideslizante **Clase 3** (según C.T.E.) / Antislip C Class / Finition antidérapante C Classe / В наличии с покрытием анти-слип.

CLASE 3

R10

Suaves relieves y destonificados / Smooth relieves and slight change of tones / Douces nuances de ton. Relief doux / Гладкая поверхность и расхождение в оттенке

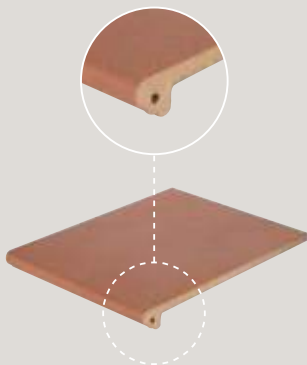

Peldaño Fiorentino
24,5 x 33 x 3 cm - 9.6x 13.2"x 1.2"

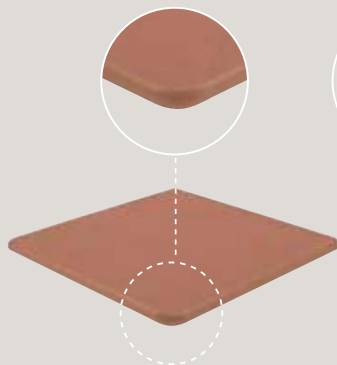

Cartabón Fiorentino
33 x 33 x 3 cm - 13.2"x 13.2"x 1.2"

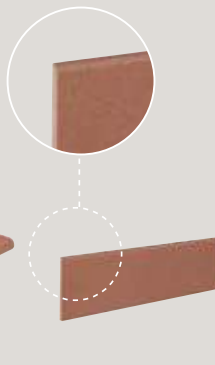

Rodapié
9 x 24,5 cm - 3.6"x 13.2"

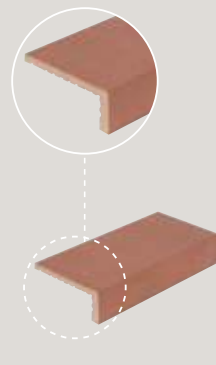

Vierteaguas
12 x 24,5 x 5 cm - 4.7"x 9.6" x 2.0"

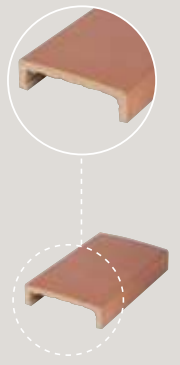

Pasamanos PAS. 12
12,5 x 24,5 cm - 4.7"x 9.6"

Pasamanos PAS. 15
15 x 24,5 cm - 5.9"x 9.6"

KLINKER EXTRUSIONADO_EXTRUDED KLINKER

Gres extrusionado de pasta blanca, esmaltado en monococción.
Extruded ceramic with white body, glazed in a single firing.
Grès étre de pâte blanche, et un émaillée produit avec une seule cuisson.
Вся серия COTO TOSCANO произведена путём экструзии из белой глины. Плитка глазуванная, одинарного обжига.



Dorso estriado en cola de milano / Dove tail profile /
Façonnage en queue d'aronde au dos des carreaux /
«Ласточкин хвост» на задней стороне плитк

Junta recomendada 5 mm / Recommended joint between
pieces 5mm / 5 mm de jointe entre chaque pièce à la mise/
с 5 мм между плитками





ATLAS
collection

SIZES

24,5x24,5 cm
12x24,5 cm

COLOURS

IRTA
MARIOLA
ESPADÁN

PETRA
collection

SIZES

33x33 cm

COLOURS

GRIS
OCRE
BONE

VEGA
collection

SIZES

33x33 cm

COLOURS

OCRE
ROJO
CAMEL
VISÓN
GRIS



S

T

p.34/49

STONE
ESSENCE

O

NE

exagres
by versatile

ATLAS
collection



Atlas Espadán
24,5x24,5 cm
Mosaico Atlas
7x24,5 cm
Rodapié Espadán
9x24,5 cm

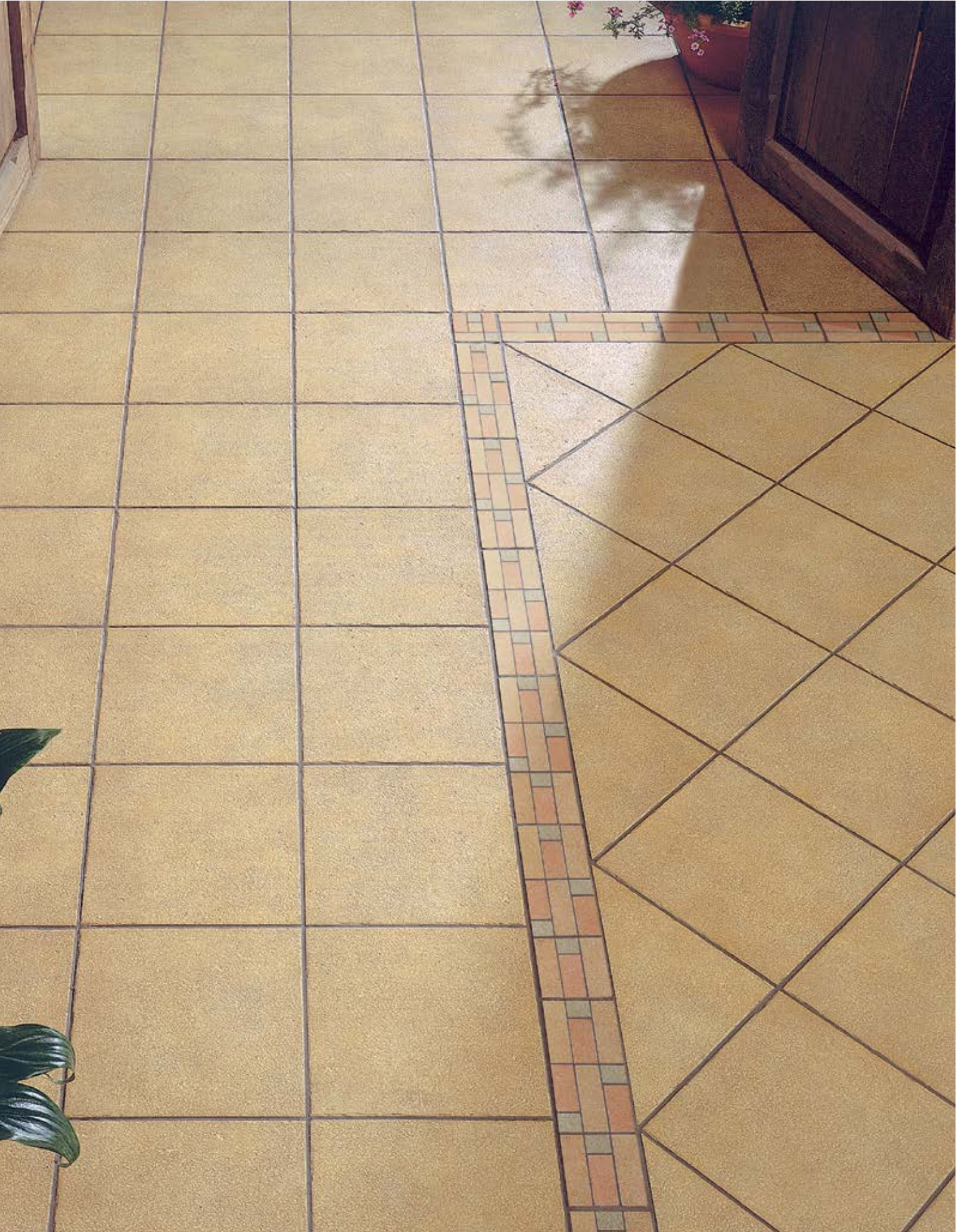







ESPADÁN

 24,5 x 24,5 cm - 9.6"x 9.6"
 12 x 24,5 cm - 4.7"x 9.6"







MARIOLA

 24,5 x 24,5 cm - 9.6"x 9.6"
 12 x 24,5 cm - 4.7"x 9.6"



IRTA

 24,5 x 24,5 cm - 9.6"x 9.6"
 12 x 24,5 cm - 4.7"x 9.6"

 Acabado antideslizante **Clase 2** (según C.T.E.) / Antislip C Class. / Finition antidérapante C Classe. / В наличии с покрытием анти-слип.
CLASE 2
 **R10**

 Relieve superficial / Superficial relief / Surface avec un peu de relief / Слегка рельефная поверхность



Tabica Natura
14 x 24,5 cm - 5.6"x 9.8"



Tabica Flora
14 x 24,5 cm - 5.6"x 9.8"



Mosaico Atlas
7 x 24,5 cm - 2.8"x 9.8"



Taco Mosaico Atlas
7 x 7 cm - 2.8"x 2.8"

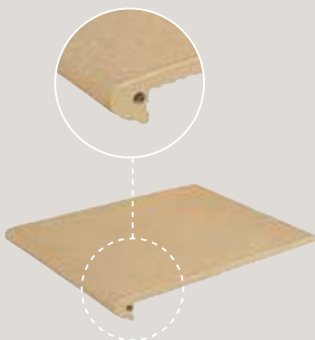

Peldaño Fiorentino
24,5 x 33 x 3 cm - 9.6"x 13.2"x 1.2"

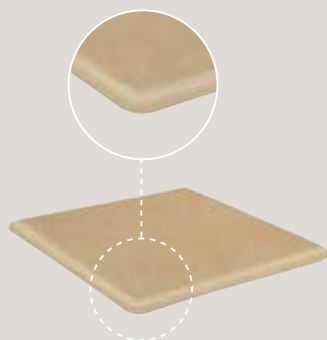

Cartabón Fiorentino
33 x 33 x 3 cm - 13.2"x 13.2"x 1.2"

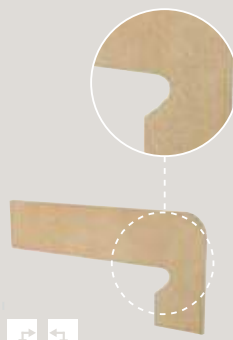

Zanquín Fiorentino **dcha./izda.**
39,5 x 17,5 cm - 15.8"x 7"

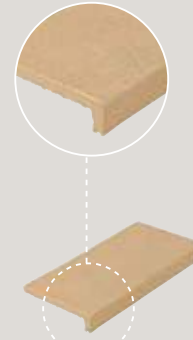

Vierteaguas
12 x 24,5 x 3 cm - 4.7"x 9.6"x 1.2"

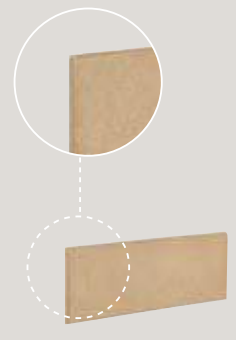

Rodapié
9 x 24,5 cm - 3.6"x 9.6"

KLINKER EXTRUSIONADO_EXTRUDED KLINKER

Gres extrusionado de pasta blanca, esmaltado en monococción. Extruded ceramic with white body, glazed in a single firing. Grès étré de pâte blanche, et un émaillée produit avec une seule cuisson. Вся серия ATLAS произведена путём экструзии из белой глины. Плитка глазурованная, одинарного обжига.

 R10
 CLASE 2
 <1,5%
 CLASS 5
 2 SIZES
 9 mm

Cantos biselados / Beveled edge / Arêtes biseautées / Скошенная кромка
 Dorsó esllnado en cola de milano / Dove tail profile / Façonnage en queue d'aronde au dos des carreaux / «Ласточкин хвост» на задней стороне плитк

Junta recomendada 5 mm / Recommended joint between pieces 5mm / 5 mm de jointe entre chaque pièce à la mise / с 5 мм между плитками

ATLAS collection



PETRA
collection

Petra
Gris
33x33 cm





PETRA
collection

Petra
Bone
33x33 cm







BONE



33 x 33 cm - 13.2"x 13.2"



OCRE



33 x 33 cm - 13.2"x 13.2"



GRIS



33 x 33 cm - 13.2"x 13.2"



CLASE 3

Acabado antideslizante
Clase 3 (según C.T.E.) /
 Antislip C Class. /
 Finition antidérapante C
 Classe. /



R10

В наличии с покрытием
 анти-слип.



Suaves relieves y
 destonificados /
 Smooth relieves and slight
 change of tones /
 Douces nuances de ton.
 Relief doux /
 Гладкая поверхность и
 расхождение в оттенке



Tabica Petra Etna

15 x 33 cm - 5.90" x 13.2"



Taco Petra Etna

8 x 8 cm - 3.15" x 3.15"



Peldaño Fiorentino

33 x 33 x 3 cm - 13.2" x 13.2" x 1.2"



Cartabón Fiorentino

33 x 33 x 3 cm - 13.2" x 13.2" x 1.2"

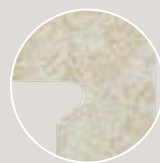

Zanquín Fiorentino dcha./izda.

39,5 x 17,5 cm - 15.8" x 7"



Rodapié

9 x 33 cm - 3.6" x 13.2"

PETRA
 collection

KLINKER EXTRUSIONADO_EXTRUDED KLINKER

Gres extrusionado de pasta blanca, esmaltado en monococción.
 Extruded ceramic with white body, glazed in a single firing.
 Grès étirée de pâte blanche, et un émaillée produit avec une seule cuisson.
 Вся серия PETRA произведена путём экструзии из белой глины. Плитка глазуванная, одинарного обжига.



R10



CLASE 3



<1,5%



CLASS 5



10 mm

Dorso estriado en cola de milano /
 Dove tail profile /
 Facelage en queue d'aronde au dos des carreaux /
 «Ласточкин хвост» на задней стороне плитк

Junta recomendada 5 mm /
 Recommended joint between pieces 5mm /
 5 mm de jointe entre chaque piece à la mise /
 с 5 мм между плитками





VEGA
collection

Vega Ocre
33x33 cm -
Cenefa Art Ferros
8x33 cm -
Rodapié Vega
Ocre
9x33 cm







OCRE



33 x 33 cm - 13.2"x 13.2"



ROJO



33 x 33 cm - 13.2"x 13.2"



CAMEL



33 x 33 cm - 13.2"x 13.2"



VISÓN



33 x 33 cm - 13.2"x 13.2"



GRIS



33 x 33 cm - 13.2"x 13.2"



Suaves relieves y destonificados
Smooth relieves and slight
change of tones /



Douces nuances de ton. Relief
doux /
Гладкая поверхность и
расхождение в оттенке

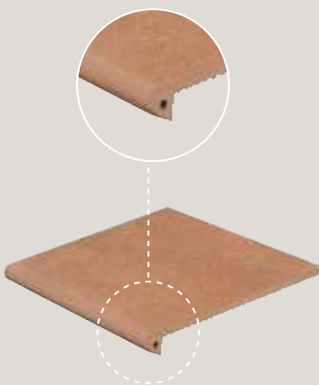

Peldaño Fiorentino
33 x 33 x 3 cm - 13.2"x 13.2"x 1.2"

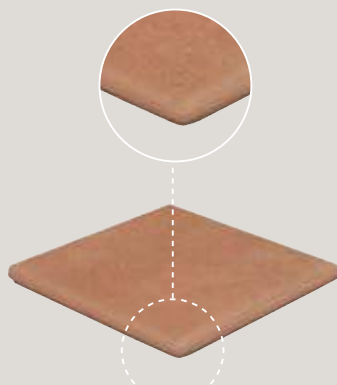

Cartabón Fiorentino
33 x 33 x 3 cm - 13.2"x 13.2"x 1.2"

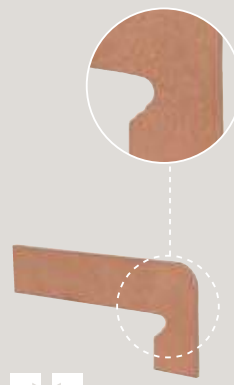

Zanquín Fiorentino **dcha./izda.**
39,5 x 17,5 cm - 15.8"x 7"

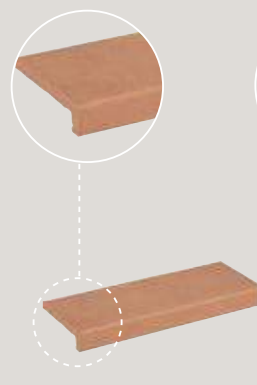

Vierteaguas
12 x 33 x 3 cm - 4.7"x 13.2" x 1.2"

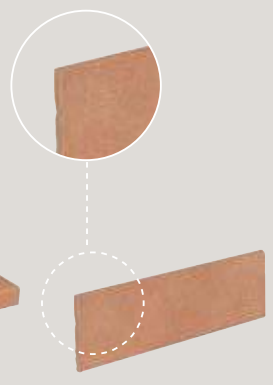

Rodapié
9 x 33 cm - 3.6"x 13.2"

KLINKER EXTRUSIONADO_EXTRUDED KLINKER

Gres extrusionado de pasta blanca, esmaltado en monococción.
Extruded ceramic with white body, glazed in a single firing.
Grès étirée de pâte blanche, et un émaillée produit avec une seule cuisson.
Вся серия VEGA произведена путём экструзии из белой глины. Плитка глазурованная, одинарного обжига.



Ángulo Mudéjar
33 x 33 cm - 13.2"x 13.2"



Recto Mudéjar
33 x 33 cm - 13.2"x 13.2"



Centro Mudéjar
33 x 33 cm - 13.2"x 13.2"



Tabica Mudéjar
15 x 33 cm - 6.0"x 13.2"



Cenefa Mudéjar
11 x 33 cm - 4.4"x 13.2"



Taco Mudéjar
11 x 11 cm - 4.4"x 4.4"



Ángulo Románico
33 x 33 cm - 13.2"x 13.2"



Recto Románico
33 x 33 cm - 13.2"x 13.2"



Centro Románico
33 x 33 cm - 13.2"x 13.2"



Tabica Románico
15 x 33 cm - 6.0"x 13.2"



Cenefa Románico
11 x 33 cm - 4.4"x 13.2"



Taco Románico
11 x 11 cm - 4.4"x 4.4"



Tabica Bizancio
15 x 33 cm - 6.0"x 13.2"



Mosaico Marea Vega
10 x 33 cm - 4"x 13.2"



Ángulo Marea Vega
10 x 10 cm - 4"x 4"

LEGEND
collection

SIZES
33x66,5 cm
33x33 cm

COLOURS
GRIS
BEIGE

MEDITERRANEO
collection

SIZES
33x66,5 cm
33x33 cm

COLOURS
ARENA
GRAFITO

PROJECTKER
ALPES
collection

SIZES
33x66,5 cm
33x33 cm
16,25x33 cm
16,25x16,25 cm

COLOURS
BLANCO
BEIGE

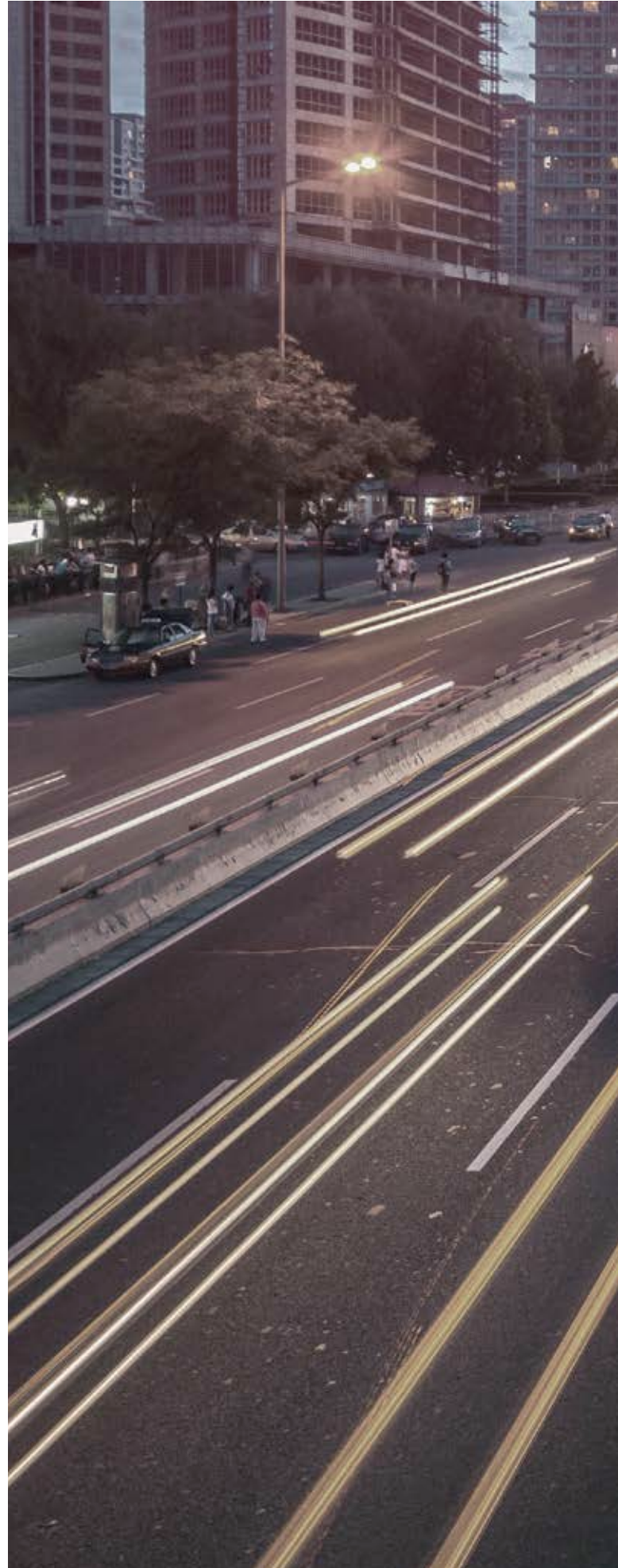

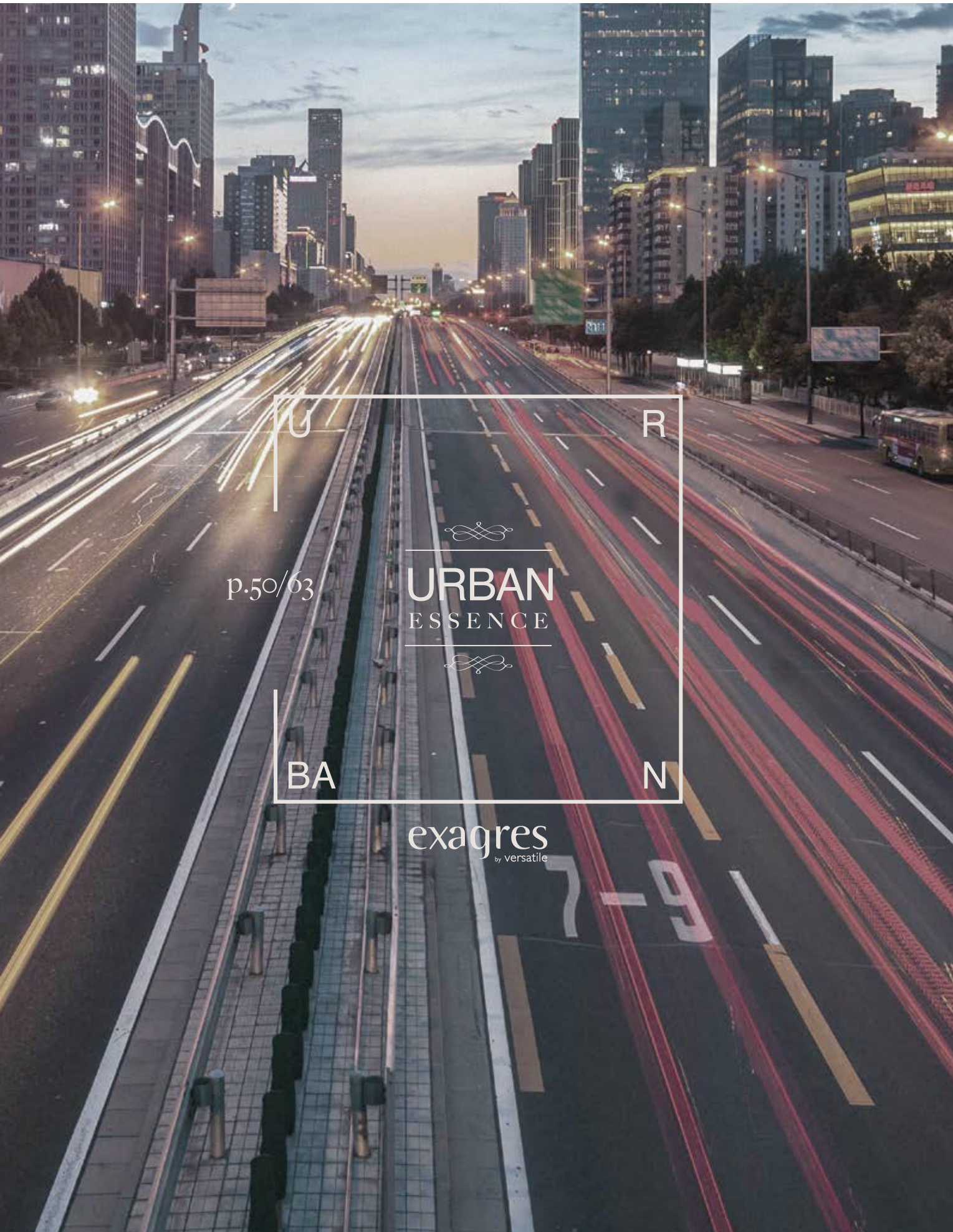

U R
BA N

p.50/63

URBAN
ESSENCE

exagres
by versatile

Legend Gris
33x66.5 cm -
Peldaño
Fiorentino
33x33x3 cm







GRIS



33 x 66,5 cm - 13.2" x 26.6"



33 x 33 cm - 13.2" x 13.2"



BEIGE



33 x 66,5 cm - 13.2" x 26.6"



33 x 33 cm - 13.2" x 13.2"



Subtlety Gris

33 x 66,5 cm - 13.2" x 26.6"



Subtlety Beige

33 x 66,5 cm - 13.2" x 26.6"



Tabica Subtlety Gris

15 x 33 cm - 5.90" x 13.2"



Tabica Subtlety Beige

15 x 33 cm - 5.90" x 13.2"



CLASE 3



R10

Nota: Disponible en acabado antideslizante **Clase 3** (según C.T.E.).
Attention: Available in antislip C Class.

Attention: Disponible avec finition antidérapante C Classe.
В наличии с покрытием анти-слип.

Suaves relieves y destonificados / Smooth relieves and slight change of tones / Douces nuances de ton. Relief doux / Гладкая поверхность и расхождение в оттенке

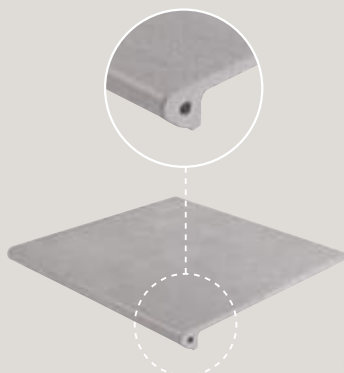

Peldaño Fiorentino

33 x 33 x 3 cm - 13.2" x 13.2" x 1.2"

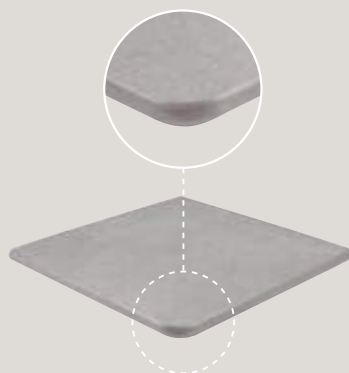

Cartabón Fiorentino

33 x 33 x 3 cm - 13.2" x 13.2" x 1.2"

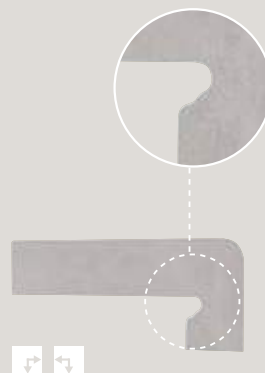

Zanquín Fiorentino dcha./izda.

39,5 x 17,5 cm - 15.8" x 7"

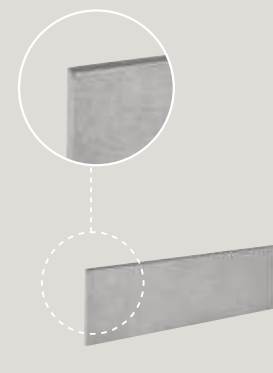

Rodapié

9 x 33 cm - 3.6" x 13.2"

LEGEND
collection

KLINKER EXTRUSIONADO / EXTRUDED KLINKER

Gres extrusionado de pasta blanca, esmaltado en monococción.

Extruded ceramic with white body, glazed in a single firing.

Grès étreñée de pâte blanche, et un émaillé produit avec une seule cuisson.

Вся серия LEGEND произведена путём экструзии из белой глины. Плитка глазурованная, одинарного обжига.



R9/R10 CLASE 1/3



<1,5%



CLASS 5



2 SIZES



10 mm

Dorso estriado en cola de milano /
Dove tail profile /
Faconnage en queue d'aronde au dos des carreaux /
«Ласточкин хвост» на задней стороне плиток

Junta recomendada 5 mm /
Recommended joint between pieces 5mm /
5 mm de jointe entre chaque pièce à la mise /
с 5 мм между плитками











ARENA

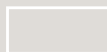

33 x 66,5 cm - 13.2"x 26.6"



33 x 33 cm - 13.2"x 13.2"

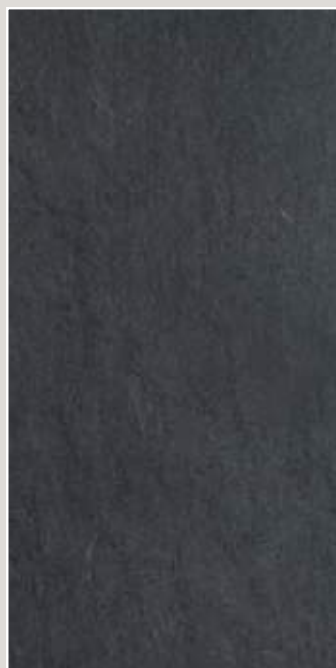

GRAFITO

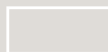

33 x 66,5 cm - 13.2"x 26.6"



33 x 33 cm - 13.2"x 13.2"



Malla Mediterráneo Mix*
33 x 33 cm - 13.2"x 13.2"



CLASE 3

Nota: Disponible en acabado antideslizante **Clase 3** (según C.T.E.). /

Attention: Available in antislip C Class. /

Attention: Disponible avec finition antidérapante C Classe. /

В наличии с покрытием анти-слип.



R11



Suaves relieves y destonificados / Smooth relieves and slight change of tones / Douces nuances de ton. Relief doux / Гладкая поверхность и расхождение в оттенке



Tabica Estambul*
15 x 33 cm - 6"x 13.2"



Mosaico Estambul*
8 x 33 cm - 3.2"x 13.2"



Mosaico Alejandría*
8 x 33 cm - 3.2"x 13.2"



MALLADO • IN MESH
MAILLE • CETKA

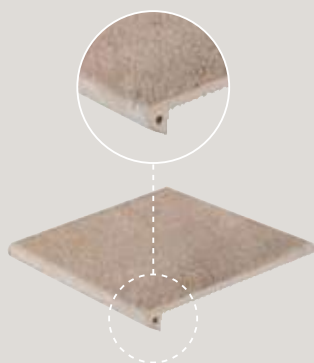

Peldaño Fiorentino
33 x 33 x 3 cm - 13.2"x 13.2"x 1.2"

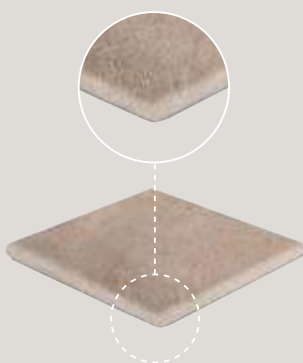

Cartabón Fiorentino
33 x 33 x 3 cm - 13.2"x 13.2"x 1.2"

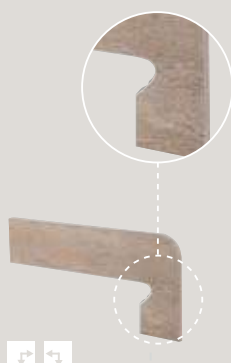

Zanquín Fiorentino dcha./izda.
39,5 x 17,5 cm - 15.8"x 7"

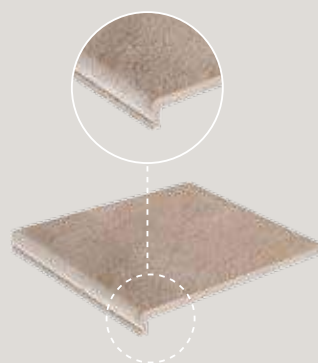

Peldaño Recto
33 x 33 x 3 cm - 13.2"x 13.2"x 1.2"

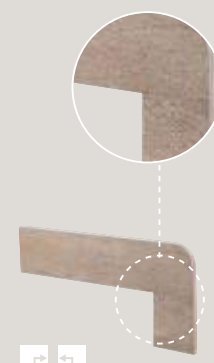

Zanquín Recto dcha./izda.
42,3 x 17,5 cm - 16.92"x 7"





Vierteguas
12 x 33 x 3 cm - 4.8" x 13.2" x 1.2"



Rodapié
9 x 33 cm - 3.6" x 13.2"



Pasamanos PAS 12
12,5 x 24,5 x 4 cm - 4.7" x 9.6" x 1.5"



Pasamanos PAS 15
15 x 24,5 x 4 cm - 5.9" x 9.6" x 1.5"



Pasamanos PAS 21
21 x 24,5 x 4 cm - 8.2" x 9.6" x 1.5"

PROJECTKER
ALPES
collection

Alpes White
33x33 cm -
16.25x33 cm -
16.25x16.25 cm -
Zanquín Fiorentino
Dcho -
Peldaño Fiorentino
33x33x3 cm -
Rodapié
9x33 cm







WHITE



33 x 66,5 cm - 13.2"x 26.6"



33 x 33 cm - 13.2"x 13.2"



16,25 x 33 cm - 6.4"x 13.2"



16,25 x 16,25 cm - 6.4"x 6.4"



BEIGE

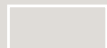

33 x 66,5 cm - 13.2"x 26.6"



33 x 33 cm - 13.2"x 13.2"



16,25 x 33 cm - 6.4"x 13.2"



16,25 x 16,25 cm - 6.4"x 6.4"



Malla Alpes White*

33 x 33 cm - 13.2"x 13.2"



Malla Alpes Beige*

33 x 33 cm - 13.2"x 13.2"

MALLADO • IN MESH
MAILLE • CETKA



CLASE 3

Nota: Disponible en acabado antideslizante **Clase 3** (según C.T.E.).
Attention: Available in antislip C Class.



R10

Attention: Disponible avec finition antidérapante C Classe.
В наличии с покрытием анти-слип.



Suaves relieves y destonificados / Smooth relieves and slight change of tones / Douces nuances de ton. Relief doux / Гладкая поверхность и расхождение в оттенке



Borde Piscina

16 x 33 cm - 6.4"x 13.2"



Ángulo Interior Piscina

20 x 20 cm - 8"x 8"



Ángulo Exterior Piscina

16 x 16 cm - 6.4"x 6.4"

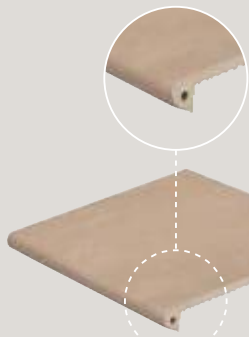

Peldaño Fiorentino

33 x 33 x 3 cm - 13.2"x 13.2"x 1.2"

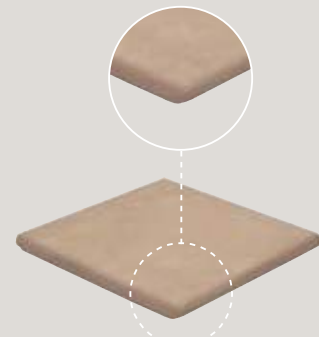

Cartabón Fiorentino

33 x 33 x 3 cm - 13.2"x 13.2"x 1.2"

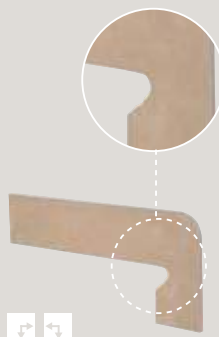

Zanquín Fiorentino dcha./izda.

39,5 x 17,5 cm - 15.8"x 7"

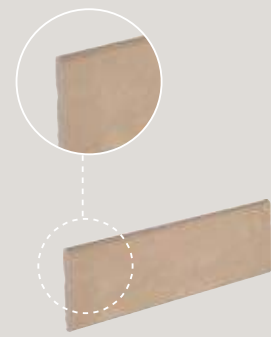

Rodapié

9 x 33 cm - 3.6"x 13.2"

PROJECTKER
ALPES
collection

KLINKER EXTRUSIONADO / EXTRUDED KLINKER

Gres extrusionado de pasta blanca, esmaltado en monococción.
Extruded ceramic with white body, glazed in a single firing.
Grès étirée de pâte blanche, et un émaillée produit avec une seule cuisson.
Вся серия PROJECTKER ALPES произведена путём экструзии из белой глины. Плитка глазурованная, одинарного обжига.

R9/R10 CLASE 1/3 <1,5% CLASS 5 4 SIZES 10 mm

Cantos biselados / Beveled edge / Arêtes biseautées / Скошенная кромка
Dorso esinado en cola de milano / Dove tail profile / Façonnage en queue d'aronde au dos des carreaux / «Ласточкин хвост» на задне стороне плитк

Junta recomendada 5 mm / Recommended joint between pieces 5mm / 5 mm de jointe entre chaque pièce à la mise / с 5 мм между плитками



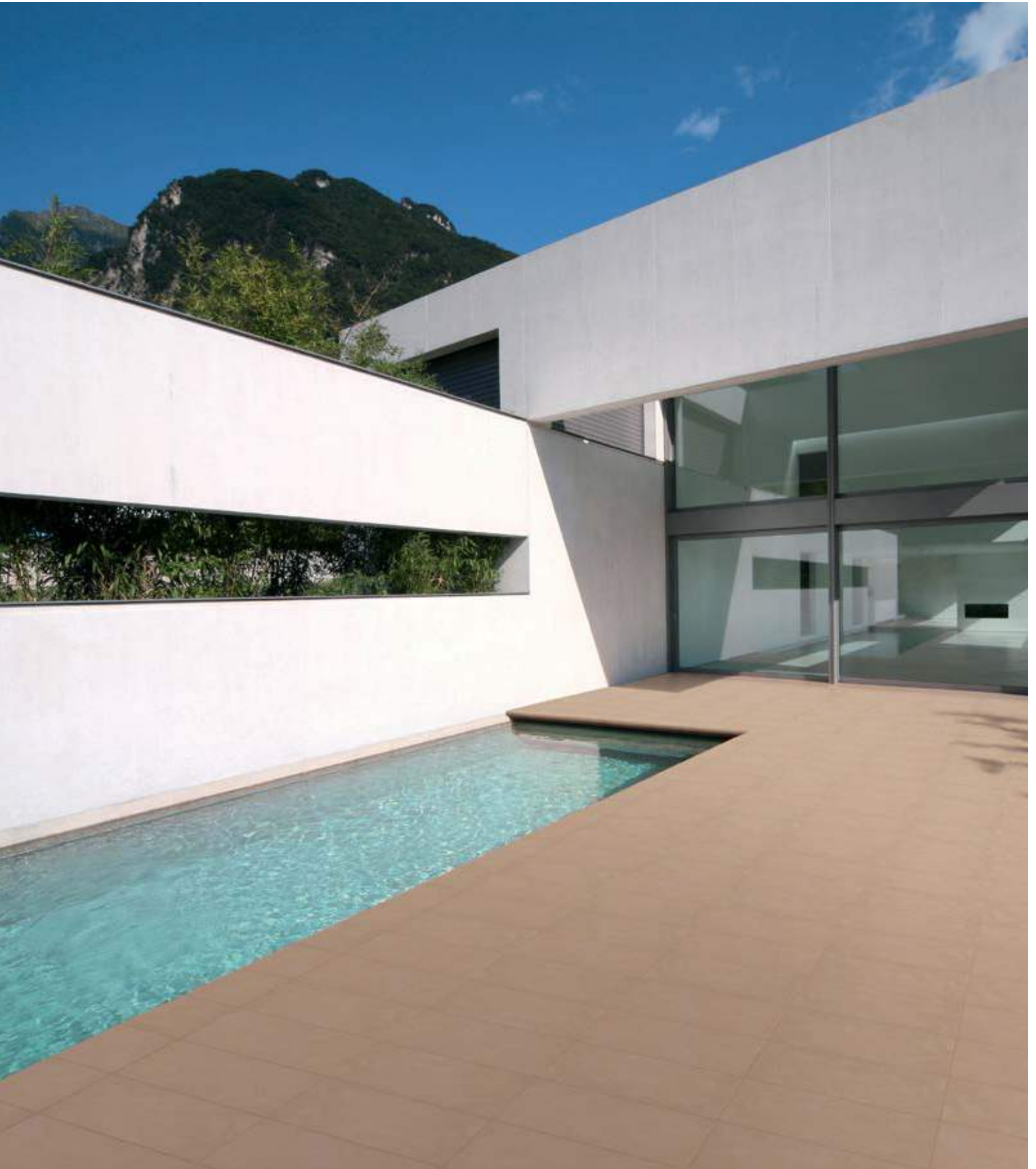

METALICA
collection

SIZES

33x33 cm

COLOURS

PURPLE
VULCANO
CHERRY
BASALT

OXIDO
collection

SIZES

33x33 cm

COLOURS

COBRE
FERRO

SILEX
collection

SIZES

16,25x66,5 cm

COLOURS

GEMA
LAVA
CORAL
MERKURIO



p.64/77



exagres
by versatile

METALICA
collection

Metálica
Purple
33x33 cm
Peldaño
Fiorentino
33x33x3cm







PURPLE



33 x 33 cm - 13.2"x 13.2"



VULCANO



33 x 33 cm - 13.2"x 13.2"



CHERRY



33 x 33 cm - 13.2"x 13.2"



BASALT



33 x 33 cm - 13.2"x 13.2"



Suaves relieves y destonificados / Smooth relieves and slight change of tones / Douces nuances de ton. Relief doux / Гладкая поверхность и расхождение в оттенке

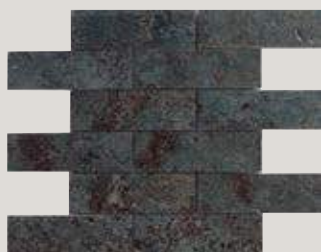

Malla Mureto Basalt*
28 x 29 cm - 11.2"x 11.2"



Malla Mureto Cherry*
28 x 29 cm - 11.2"x 11.2"



MALLADO • IN MESH
MAILLE • CETKA

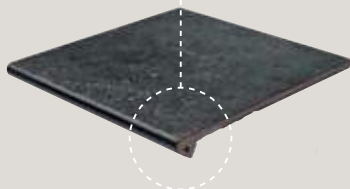

Peldaño Fiorentino
33 x 33 x 3 cm - 13.2"x 13.2"x 1.2"

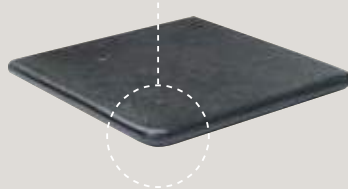

Cartabón Fiorentino
33 x 33 x 3 cm - 13.2"x 13.2"x 1.2"



Zanquín Fiorentino dcha./izda.
39,5 x 17,5 cm - 15.8"x 7"

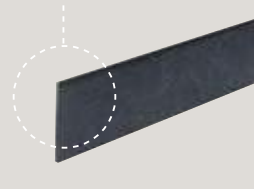

Rodapié
9 x 33 cm - 3.6"x 13.2"

METALICA
collection

KLINKER EXTRUSIONADO, EXTRUDED KLINKER

Gres extrusionado de pasta blanca, esmaltado en monococción. Extruded ceramic with white body, glazed in a single firing. Gres étirée de pâte blanche, et un émaillée produit avec une seule cuisson. Вся серия METALICA произведена путём экструзии из белой глины. Плитка глазурованная, одинарного обжига.



10 mm

R9

CLASE 1

<1,5%

CLASS 5

Cantos biselados / Beveled edge / Arêtes biseaulées / Скошенная кромка

Dorso esinado en cola de milano / Dove tail profile / Façonnage en queue d'aronde au dos des carreaux / «Ласточкин хвост» на задние стороне плиток

Junta recomendada 5 mm / Recommended joint between pieces 5mm / 5 mm de jointe entre chaque pièce à la mise / с 5 мм между плитками



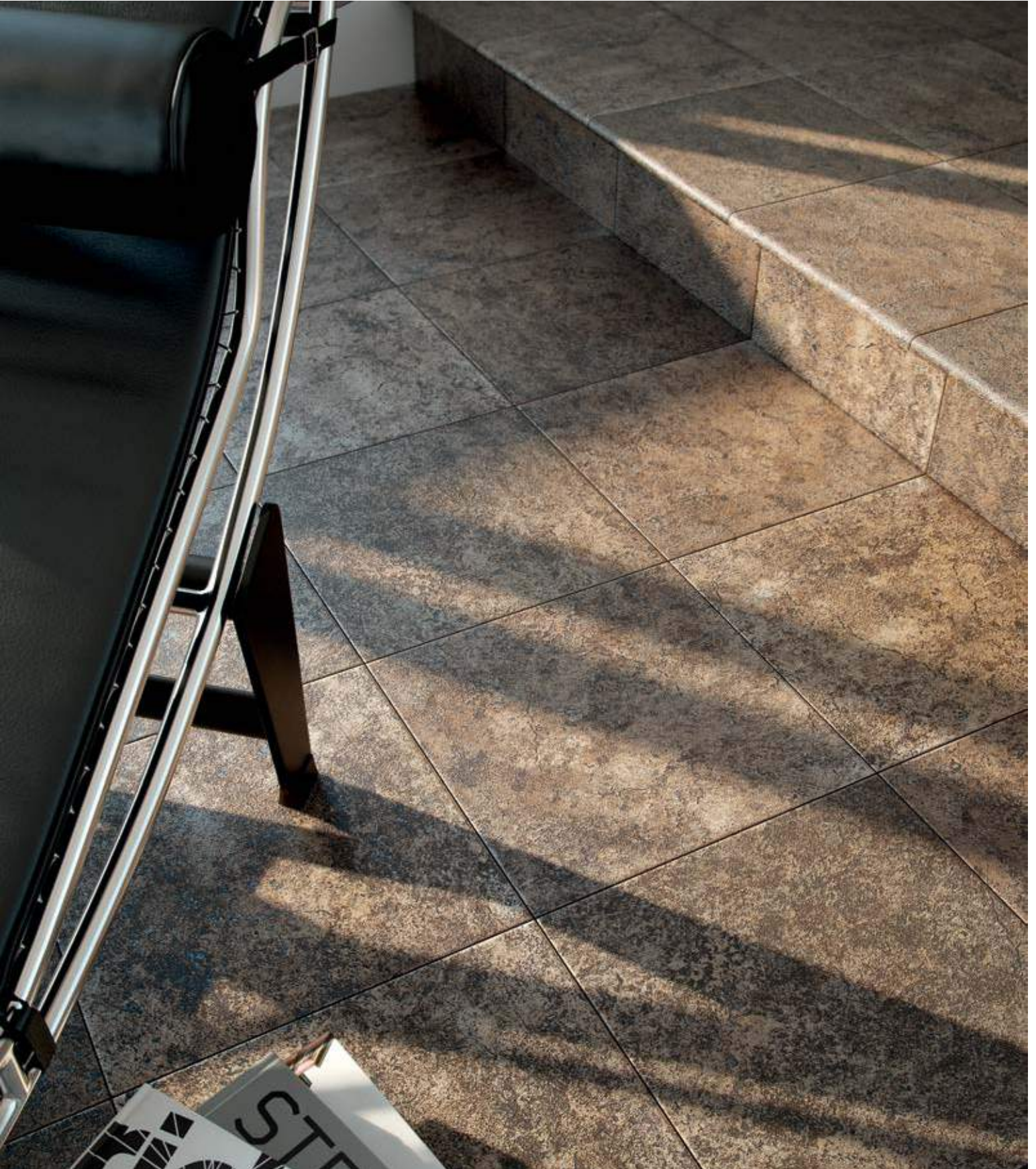

OXIDO
collection

Óxido Cobre
33x33 cm







COBRE



33 x 33 cm - 13.2"x 13.2"



FERRO



33 x 33 cm - 13.2"x 13.2"



Suaves relieves y destonificados - Smooth relieves and slight change of tones
Douce nuances de ton. Relief doux - Гладкая поверхность и расхождение в оттенке

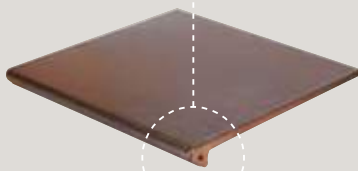

Peldaño Fiorentino
33 x 33 x 3 cm - 13.2"x 13.2"x 1.2"



Cartabón Fiorentino dcha./izda.
33 x 33 x 3 cm - 13.2"x 13.2"x 1.2"



Zanquín Fiorentino dcha./izda.
39,5 x 17,5 cm - 15.8"x 7"



Rodapié
9 x 33 cm - 3.6"x 13.2"

OXIDO
collection

KLINKER EXTRUSIONADO_EXTRUDED KLINKER

Gres extrusionado de pasta blanca, esmaltado en monococción.
Extruded ceramic with white body, glazed in a single firing.
Grès étirée de pâte blanche, et un émaillée produit avec une seule cuisson.
Вся серия OXIDO произведена путём экструзии из белой глины. Плитка глазурованная, одинарного обжига.



Cantos biselados / Beveled edge / Arêtes biseaulées /
Оскошенная кромка

Dorso esinado en cola de milano / Dove tail profile /
Raspillage en queue d'aronde au dos des carreaux /
«Ласточкин хвост» на задней стороне плитк

Junta recomendada 5 mm / Recommended joint between
pieces 5mm / 5 mm de jointe entre chaque pièce à la mise
/ с 5 мм между плитками





SILEX
collection

Silex
Mercurio
16,25x66,5 cm

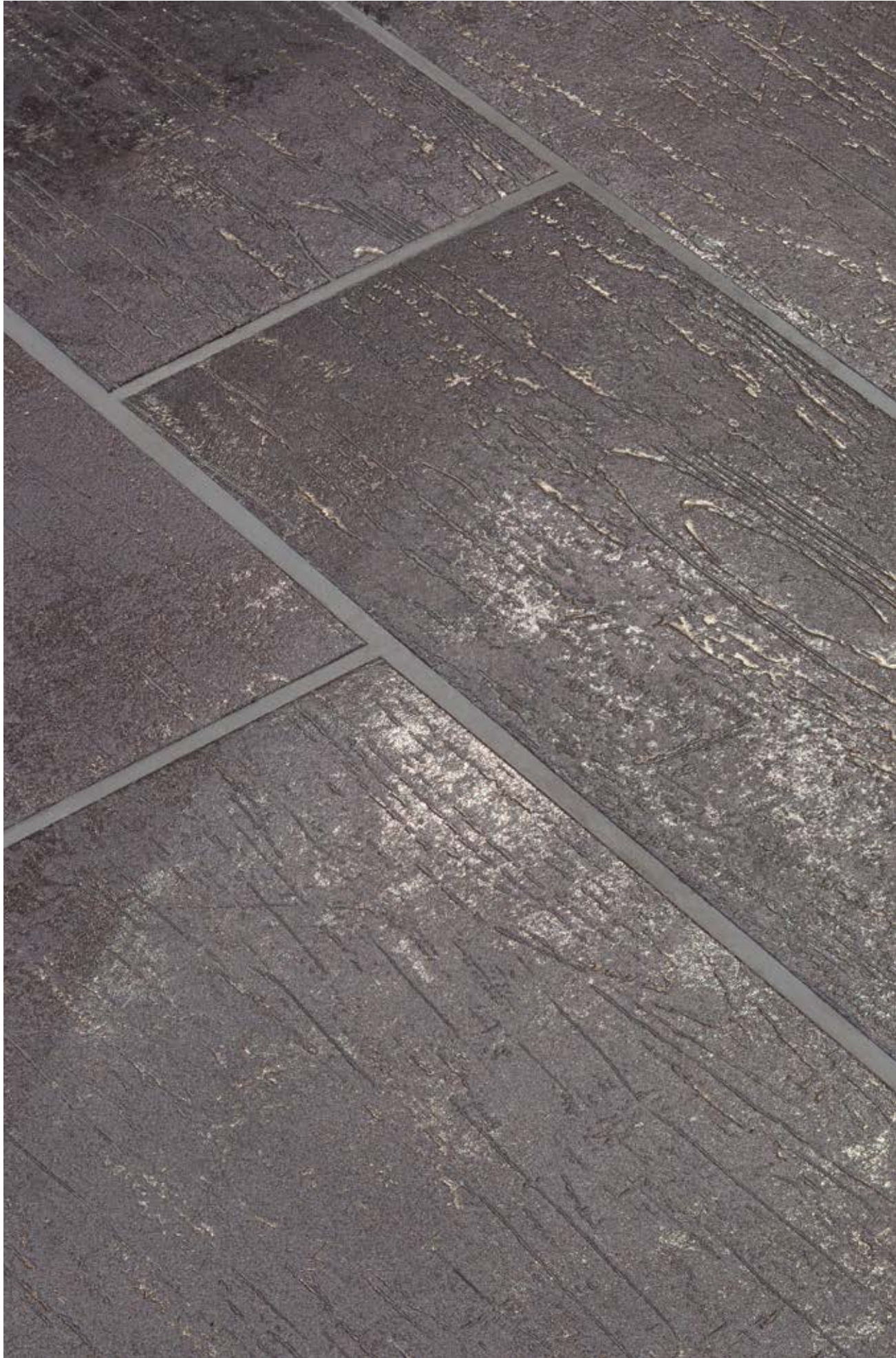

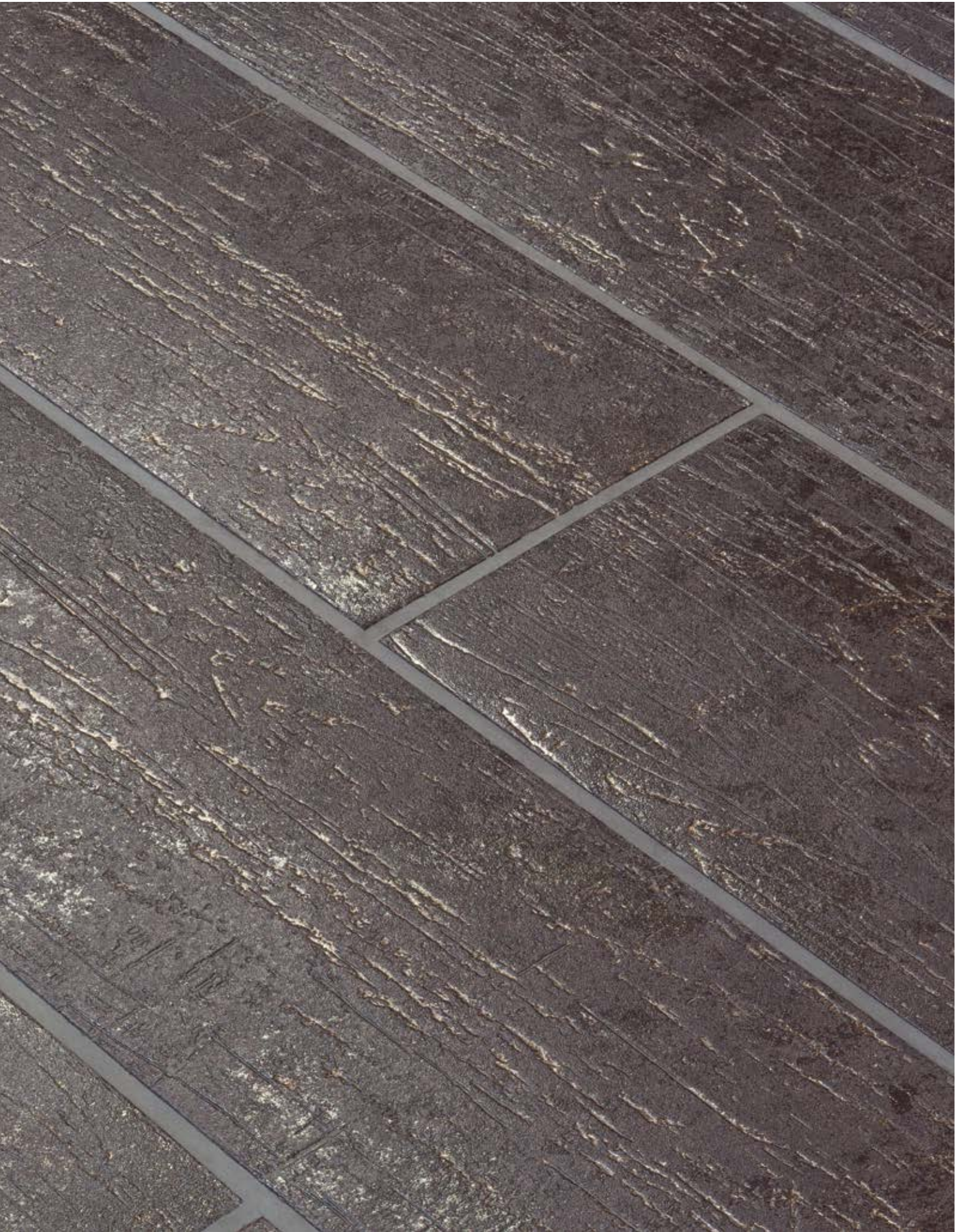



GEMA

16,25 x 66,5 cm -
6.4 x 26.2"



LAVA

16,25 x 66,5 cm -
6.4 x 26.2"



CORAL

16,25 x 66,5 cm -
6.4 x 26.2"



MERKURIO

16,25 x 66,5 cm -
6.4 x 26.2"



Suaves relieves y destonificados / Smooth relieves and slight change of tones /
Douce nuance de ton. Relief doux / Гладкая поверхность и расхождение в оттенке

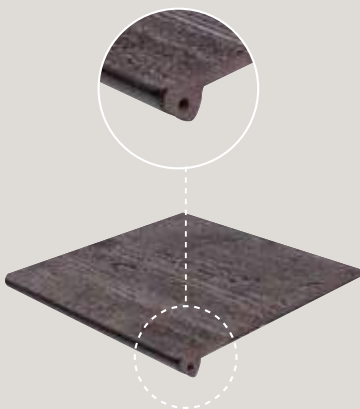

Peldaño Fiorentino
33 x 33 x 3 cm - 13.2"x 13.2"x 1.2"

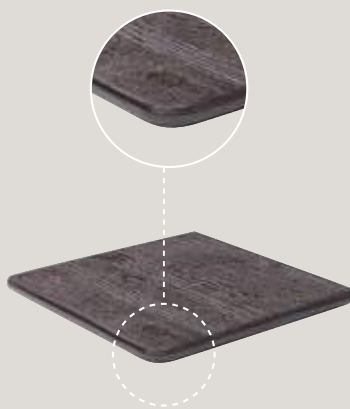

Cartabón Fiorentino
33 x 33 x 3 cm - 13.2"x 13.2"x 1.2"

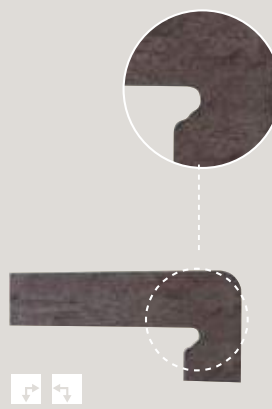

Zanquín Fiorentino dcha./izda.
39,5 x 17,5 cm - 15.8"x 7"

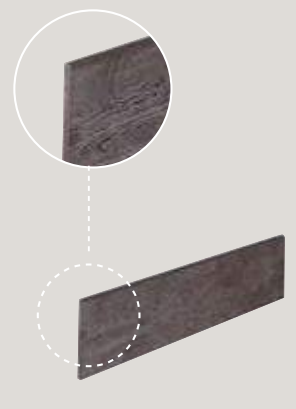

Rodapié
9 x 33 cm - 3.6"x 13.2"

SILEX
collection

KLINKER EXTRUSIONADO, EXTRUDED KLINKER

Gres extrusionado de pasta blanca, esmaltado en monococción.
Extruded ceramic with white body, glazed in a single firing.
Gres étirée de pâte blanche, et un émailée produit avec une seule cuisson.
Вся серия SILEX произведена путём экструзии из белой глины. Плитка глазурованная, одинарного обжига.



R9



CLASE 1



<1.5%



CLASS 5



10 mm

Cantos biselados / Beveled edge / Arêtes biseaulées /
Оскошенная кромка

Dorso esinado en cola de milano / Dove tail profile /
Faisonnage en queue d'aronde au dos des carreaux /
«Ласточкин хвост» на задней стороне плитк

Junta recomendada 5 mm / Recommended joint between
pieces 5mm / 5 mm de jointe entre chaque pièce à la mise
/ с 5 мм между плитками





ART
collection

La colección de decorados ART, ofrece interesantes y vistosas soluciones con relieves, texturas y acabados que combinan con la amplia gama de producto de Exagres.

ART decor collection offers interesting and nice solutions with reliefs, textures and finishes combining with the wide range of Exagres products.

La collection de décors ART offre des solutions très intéressantes avec des reliefs, textures et finitions en assortiment avec la large gamme de produits Exagres.

Коллекция декоративных элементов ART предлагает интересные и эффектные решения с поверхностями, текстурами и рельефами, сочетающимися с широкой гаммой продукции Эксагреса.



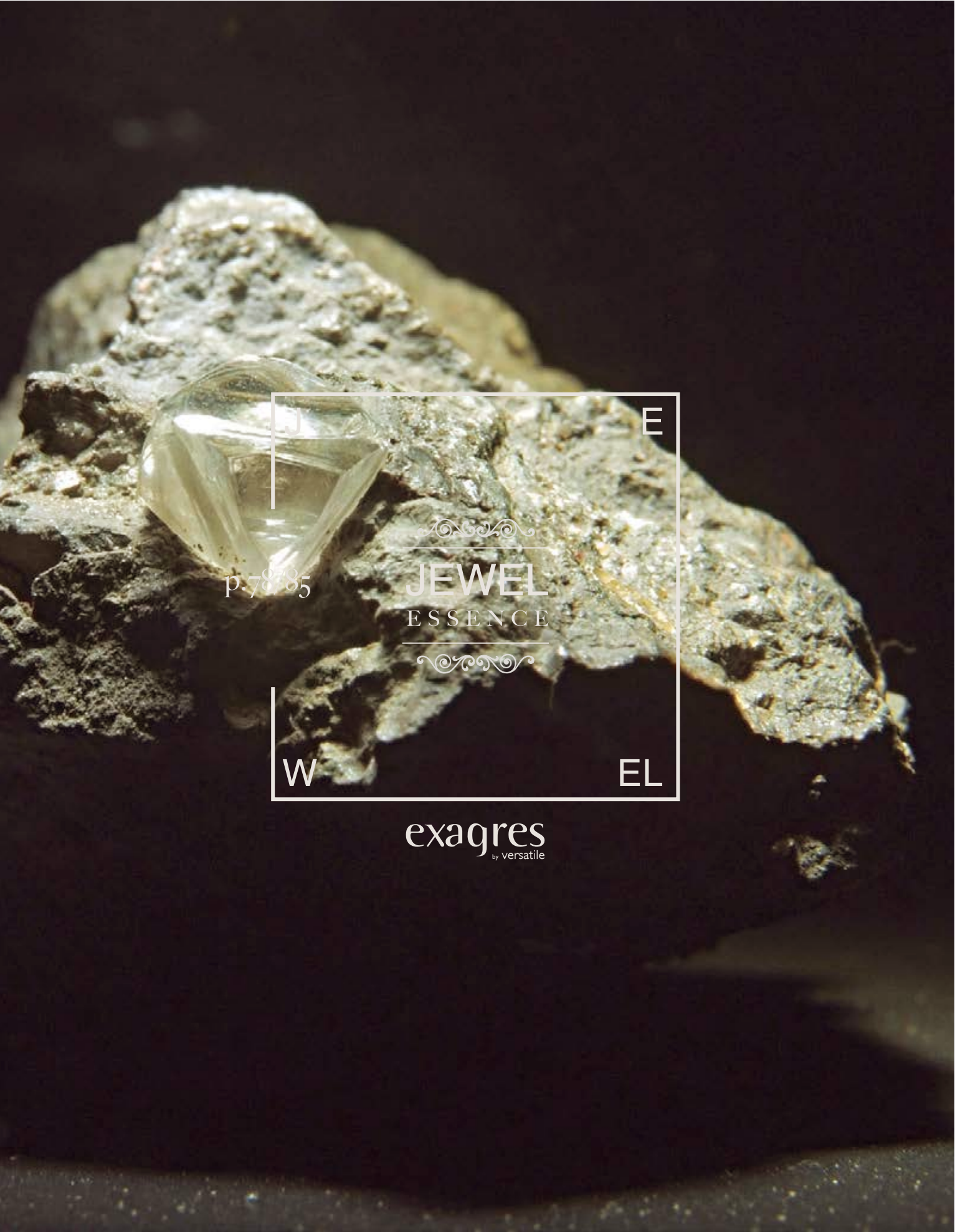

J E
W EL

p.78/85

JEWEL
ESSENCE

exagres
by versatile

ART
collection

Cenefa
Magma
5x33 cm -
Mediterráneo
Grafito
33x66,5 cm











Cenefa Magma
5 x 33 cm - 2"x 13.2"



Cenefa Thera
8 x 33 cm - 3.2"x 13.2"



Cenefa Ferros
8 x 33 cm - 3.2"x 13.2"

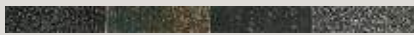

Cenefa Gneis
2 x 32 cm - 0.8"x 12.8"

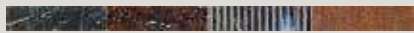

Cenefa Vulcano
2 x 32 cm - 0.8"x 12.8"



Cenefa Mariscal
15 x 33 cm - 5.90"x 13.2"



Tacos Mariscal (surtido)
10 x 10 cm - 3.94"x 3.94"



MALLADO • IN MESH
MAILLE • CETKA















CARACTERÍSTICAS TÉCNICAS - TECHNICAL DATA - CARACTÉRISTIQUES TECHNIQUES - ТЕХНИЧЕСКИЕ ХАРАКТЕРИСТИКИ

						
COLLECCIÓN COLLECTION	UNE-EN ISO 10545-3	UNE-EN ISO 10545-4	PEI UNE-EN ISO 10545-7	UNE-EN ISO 10545-9	UNE-EN ISO 10545-11	
STONE	ATLAS	< 1,5%	>30 N/MM2	III irita/espadán IV mariola	garantizado guaranteed garanti Гарантированно	garantizado guaranteed garanti Гарантированно
	VEGA	< 1,5%	>30 N/MM2	II rojo/rojo anti-slip III camel/ocre/visón IV ocre anti-slip/gris V camel anti-slip/gris anti-slip/visón anti-slip	garantizado guaranteed garanti Гарантированно	garantizado guaranteed garanti Гарантированно
	PETRA	< 1,5%	>30 N/MM2	IV	garantizado guaranteed garanti Гарантированно	garantizado guaranteed garanti Гарантированно
WOOD	TAIGA	< 1,5%	>30 N/MM2	I ebano III cerezo/pino IV abedul	garantizado guaranteed garanti Гарантированно	garantizado guaranteed garanti Гарантированно
	NATURA	< 1,5%	>30 N/MM2	IV	garantizado guaranteed garanti Гарантированно	garantizado guaranteed garanti Гарантированно
URBAN	PROJECTKER ALPES	< 1,5%	>30 N/MM2	IV	garantizado guaranteed garanti Гарантированно	garantizado guaranteed garanti Гарантированно
	MEDITERRÁNEO	< 1,5%	>30 N/MM2	II grafito IV arena	garantizado guaranteed garanti Гарантированно	garantizado guaranteed garanti Гарантированно
	LEGEND	< 1,5%	>30 N/MM2	III gris IV beige	garantizado guaranteed garanti Гарантированно	garantizado guaranteed garanti Гарантированно
METAL	METÁLICA	< 1,5%	>35 N/MM2	III	garantizado guaranteed garanti Гарантированно	garantizado guaranteed garanti Гарантированно
	ÓXIDO	< 1,5%	>30 N/MM2	III	garantizado guaranteed garanti Гарантированно	garantizado guaranteed garanti Гарантированно
	SILEX	< 1,5%	>35 N/MM2	III	garantizado guaranteed garanti Гарантированно	garantizado guaranteed garanti Гарантированно
EARTH	ALHAMAR	< 1,5%	>30 N/MM2	III rojo IV blanco/paja/salmón	garantizado guaranteed garanti Гарантированно	garantizado guaranteed garanti Гарантированно
	COTO TOSCANO	< 1,5%	>30 N/MM2	III	garantizado guaranteed garanti Гарантированно	garantizado guaranteed garanti Гарантированно

ICONOGRAFÍA - ICONOGRAPHY - ICONOGRAPHIE - УСЛОВНЫЕ ОБОЗНАЧЕНИЯ

					
DIMENSIONES DIMENSIONS & SURFACE QUALITY DIMENSIONS РАЗМЕРЫ	ABSORCIÓN DE AGUA WATER ABSORPTION ABSORPTION D'EAU ВОДОПОГЛОЩЕНИЕ	RESISTENCIA A LA FLEXIÓN MODULUS OF RUPTUR RÉSISTANCE A LA FLEXION СОПРОТИВЛЕНИЕ НА ИЗГИБ	RESISTENCIA A LA ABRASIÓN (PEI) DEEP ABRASION RESISTANCE RÉSISTANCE A L'ABRASION СТОЙКОСТЬ К ИСТИРАНИЮ ПОВЕРХНОСТИ	RESISTENCIA AL CHOQUE TÉRMICO THERMAL SHOCK RESISTANCE RÉSIST. AUX VARIATIONS THERMIQUES СТОЙКОСТЬ К ТЕПЛОВЫМ ПЕРЕПАДАМ	RESISTENCIA AL CUARTEO CRACKING RESISTANCE RÉSISTANCE AU TRESSAILLAGE УСТОЙЧИВОСТЬ К РАСТРЕСКИВАНИЮ

						
UNE-EN ISO 10545-12	UNE-EN ISO 10545-13			UNE-EN ISO 10545-14	NORMA DIN 51130	UNE-ENV 12633/2003
garantizado guaranteed garanti Гарантированно	GA	GLA	GHA	CLASE 5	R10	CLASE 2
garantizado guaranteed garanti Гарантированно	GA	GLA	GHA	CLASE 5	R9 normal	CLASE 1 normal
					R10 anti-slip	CLASE 2 anti-slip
garantizado guaranteed garanti Гарантированно	GA	GLA	GHA	CLASE 5	R10	CLASE 3
garantizado guaranteed garanti Гарантированно	GA	GLA	GHA	CLASE 5	R9	CLASE 1
garantizado guaranteed garanti Гарантированно	GA	GLA	GHA	CLASE 5	R10	CLASE 3
garantizado guaranteed garanti Гарантированно	GA	GLA	GHA	CLASE 5	R9 normal	CLASE 1 normal
					R10 anti-slip	CLASE 3 anti-slip
garantizado guaranteed garanti Гарантированно	GA	GLA	GHA	CLASE 5	R9 normal	CLASE 1 normal
					R11 anti-slip	CLASE 3 anti-slip
garantizado guaranteed garanti Гарантированно	GA	GLA	GHA	CLASE 5	R9 normal	CLASE 1 normal
					R10 anti-slip	CLASE 3 anti-slip
garantizado guaranteed garanti Гарантированно	GA	GLA-GLB	GHA-GHB	CLASE 5	R9	CLASE 1
garantizado guaranteed garanti Гарантированно	GA	GLA-GLB	GHA-GHB	CLASE 5	R9	CLASE 1
garantizado guaranteed garanti Гарантированно	GA	GLA-GLB	GHA-GHB	CLASE 5	R9	CLASE 1
garantizado guaranteed garanti Гарантированно	GA	GLA-GLB	GHA-GHB	CLASE 5	R9	CLASE 2
garantizado guaranteed garanti Гарантированно	GA	GLA	GHA	CLASE 5	R10	CLASE 3



RESISTENCIA A LA HELADA
FROST RESISTANCE
RESISTANCE AU GEL
МОРОЗОСТОЙКОСТЬ



RESISTENCIA A LOS AGENTES QUÍMICOS
CHEMICAL RESISTANCE
RESISTANCE AUX PRODUITS CHIMIQUES
СТОЙКОСТЬ К ВОЗДЕЙСТВИЮ ХИМИКАТОВ



RESISTENCIA A LAS MANCHAS
STAIN RESISTANCE
RÉSISTANCE AUX TACHES
УСТОЙЧИВОСТЬ К ОБРАЗОВАНИЮ ПЯТЕН



RESISTENCIA AL DESLIZAMIENTO (pie calzado)
ANTI-SLIP RESISTANCE (barefoot)
RESISTANCE AU GLISSEMENT (piéd chaussé)
СОПРОТИВЛЕНИЕ СКОЛЬЖЕНИЮ (если ходит обувью)



RESISTENCIA AL DESLIZAMIENTO (C.T.E.)
ANTI-SLIP RESISTANCE
RESISTANCE AU GLISSEMENT (C.T.E.)
СОПРОТИВЛЕНИЕ СКОЛЬЖЕНИЮ (C.T.E.)



CONTINUIDAD ESTÉTICA
AESTHETIC CONTINUITY
CONTINUITÉ DE L'ESTHÉTIQUE
НЕРАЗРЫВНОСТЬ ЭСТЕТИКИ

EMBALAJE - PACKING - EMBALLAGE - УПАКОВКА

COLLECCIÓN COLLECTION		FORMATO • SIZE FORMAT • PAЗMEP	MEDICIONES • MEASUREMENTS MESURE • ШИТКИ/ м	CAJAS • BOXES BOITES • КОРОБКИ	PALETS • PALLETS PALLETES • ПАЛЛЕТЫ
STONE	ATLAS	Base 24,5x24,5 cm	16 pcs. / m ²	16 pcs. / 19,89 Kg	72 boxes / 1435 Kg
		Base 12x24,5 cm	32 pcs. / m ²	33 pcs. / 18,32 Kg	72 boxes / 1321 Kg
		Listelo 5,75x24,5 cm (doble)	64 pcs. / m ²	66 pcs. / 18,58 Kg	72 boxes / 1341 Kg
		Tabica 14x24,5 cm	4 pcs. / ml	12 pcs. / 7 Kg	-
		Rodapié 9x24,5 cm	4 pcs. / ml	32 pcs. / 12,11 Kg	84 boxes / 1019 Kg
		Vierteaguas 12x24,5x3 cm	4 pcs. / ml	16 pcs. / 14,02 Kg	72 boxes / 1054 Kg
		Peldaño Fiorentino 24,5x33x3 cm	4 pcs. / ml	4 pcs. / 9,30 Kg	72 boxes / 672 Kg
		Cartabón Fiorentino 33x33x3 cm	-	1 pcs. / 4,29 Kg	82 boxes
Zanquín Fiorentino 39,5x17,5 cm	-	14 pcs. / 10,28 Kg	68 boxes		
STONE	VEGA	Base 33x33 cm	9 pcs. / m ²	9 pcs. / 22,20 Kg	48 boxes / 1070 Kg
		Rodapié 9x33 cm	3 pcs. / m ²	24 pcs. / 13,90 Kg	72 boxes / 1010 Kg
		Vierteaguas 12x33x3 cm	3 pcs. / m ²	16 pcs. / 18,00 Kg	50 boxes / 900 Kg
		Peldaño Fiorentino 33x33x3 cm	3 pcs. / m	4 pcs. / 12,50 Kg	48 boxes / 610 Kg
		Cartabón Fiorentino 33x33x3 cm	-	1 pcs. / 4,00 Kg	82 boxes / 340 Kg
		Zanquín Fiorentino 39,5x17,5 cm	-	14 pcs. / 10,00 Kg	68 boxes
		Mosaicos 10x30 cm	3 pcs. / ml	9 pcs. / 6,50 Kg	-
		Ángulo mosaicos 10x10 cm	-	27 pcs. / 6,00 Kg	-
		Decorados 33x33 cm	-	4 pcs. / 9,60 Kg	-
		Tabica 15x33 cm	3 pcs. / ml	12 pcs. / 13,20 Kg	-
		Cenefa 11x33 cm	3 pcs. / ml	12 pcs. / 12,00 Kg	-
		Taco 11x11 cm	-	36 pcs. / 10,80 Kg	-
STONE	PETRA	Base 33x33 cm	9 pcs. / m ²	9 pcs. / 22,20 Kg	48 boxes / 1070 Kg
		Rodapié 9x33 cm	3 pcs. / ml	24 pcs. / 14 Kg	72 boxes / 1010 Kg
		Peldaño Fiorentino 33x33x3 cm	3 pcs. / ml	4 pcs. / 12,50 Kg	48 boxes / 610 Kg
		Cartabón Fiorentino 33x33x3 cm	-	1 pcs. / 4,00 Kg	82 boxes / 340 Kg
		Zanquín Fiorentino 39,5x17,5 cm	-	14 pcs. / 10,00 Kg	68 boxes
		Taco Petra Etna 8x8 cm	-	-	-
		Tabica Etna Petra 15x33 cm	3 pcs. / ml	12 pcs. / 13,20 Kg	-
WOOD	NATURA	Base 16,25x66,5 cm	9 pcs. / m ²	10 pcs. / 25,68 Kg	40 boxes / 1025 Kg
		Rodapié 9x33 cm	3 pcs. / ml	24 pcs. / 14,00 Kg	72 boxes / 1010 Kg
		Peldaño Fiorentino 33x33x3 cm	3 pcs. / ml	4 pcs. / 12,50 Kg	48 boxes / 610 Kg
		Cartabón Fiorentino 33x33x3 cm	-	1 pcs. / 4,00 Kg	82 boxes / 340 Kg
		Zanquín Fiorentino 39,5x17,5 cm	-	14 pcs. / 10,00 Kg	68 boxes
		Borde piscina 28x66,5 cm	-	-	-
		Ángulo Interior 33x33 cm	-	-	-
		Ángulo exterior 28x28 cm	-	-	-
WOOD	TAIGA	Base 33x66,5 cm	4,5 pcs. / m ²	5 pcs. / 25,68 Kg	40 boxes / 1025 Kg
		Base 16,25x66,5 cm	9 pcs. / m ²	10 pcs. / 25,60 Kg	40 boxes / 1022 Kg
		Rodapié 9x33 cm	3 pcs. / ml	24 pcs. / 14,00 Kg	72 boxes / 1010 Kg
		Vierteaguas 12x33x3 cm	3 pcs. / ml	16 pcs. / 18,00 Kg	50 boxes / 900 Kg
		Peldaño Fiorentino 33x33x3 cm	3 pcs. / ml	4 pcs. / 12,50 Kg	48 boxes / 610 Kg
		Cartabón Fiorentino 33x33x3 cm	-	1 pcs. / 4,00 Kg	82 boxes / 340 Kg
		Zanquín Fiorentino 39,5x17,5 cm	-	14 pcs. / 10,00 Kg	68 boxes
		Peldaño Recto 33x33x3 cm	3 pcs. / ml	4 pcs. / 12,50 Kg	48 boxes / 610 Kg
		Zanquín Recto 42,3x17x5 cm	-	14 pcs. / 10,00 Kg	68 boxes
		Listelo 3x66,5 cm	-	12 pcs. / 12,00 Kg	-
EARTH	COTO TOSCANO	Base 24,5x24,5 cm	16 pcs. / m ²	16 pcs. / 20 Kg	72 boxes / 1435 Kg
		Base 12x24,5 cm	32 pcs. / m ²	33 pcs. / 18,52 Kg	72 boxes / 1322 Kg
		Rodapié 8x24,5 cm	4 pcs. / ml	32 pcs. / 12,11 Kg	84 boxes / 1020 Kg
		Vierteaguas 12x24,5x5 cm	4 pcs. / ml	16 pcs. / 14,12 Kg	66 boxes / 1056 Kg
		Peldaño Fiorentino 24,5x33x3 cm	4 pcs. / ml	4 pcs. / 9,3 Kg	72 boxes / 960 Kg
		Cartabón Fiorentino 33x33x3 cm	-	1 pcs. / 4,29 Kg	82 boxes / 352 Kg
		Pasamanos 12,5x24,5 cm	4 pcs. / ml	12 pcs. / 15,20 Kg	45 boxes / 685 Kg
		Pasamanos 15x24,5 cm	4 pcs. / ml	12 pcs. / 15,20 Kg	39 boxes / 668,32 Kg

COLLECCIÓN COLLECTION		FORMATO • SIZE FORMAT • РАЗМЕР	MEDICIONES • MEASUREMENTS MESURE • ШТУКИ/ м	CAJAS • BOXES BOITES • КОРОБКИ	PALETS • PALLETS PALLETTES • ПАЛЛЕТЫ	
EARTH	ALHAMAR	Base 33x33 cm	9 pcs. / m ²	9 pcs. / 22,20 Kg	48 boxes / 1070 Kg	
		Base 16,25x33 cm	18 pcs. / m ²	18 pcs. / 22,20 Kg	56 boxes / 1250 Kg	
		Base 16,25x16,25 cm	36 pcs. / m ²	18 pcs. / 11,10 Kg	120 boxes / 1340 Kg	
		Rodapié 9x33 cm	3 pcs. / ml	24 pcs. / 14,00 Kg	72 boxes / 1000 Kg	
		Peldaño Fiorentino 33x33x3 cm	3 pcs. / ml	4 pcs. / 12,50 Kg	48 boxes / 610 Kg	
		Cartabón Fiorentino 33x33x3 cm	-	1 pcs. / 4,00 Kg	82 boxes / 340 Kg	
		Zanquín Fiorentino 39,5x17,5 cm	-	14 pcs. / 10,00 Kg	68 boxes	
		Vierteaguas 15x33x4 cm	-	-	-	
URBAN	PROJECTKER ALPES	Base 33x66,5 cm	4,5 pcs. / m ²	5 pcs. / 25,68 Kg	40 boxes / 1025 Kg	
		Base 16x33 cm	18 pcs. / m ²	18 pcs. / 22,20 Kg	56 boxes / 1250 Kg	
		Base 33x33cm	9 pcs. / m ²	9 pcs. / 22,20 Kg	48 boxes / 1070 Kg	
		Base 16,25x16,25 cm	36 pcs. / ml	18 pcs. / 11,10 Kg	120 boxes / 1340Kg	
		Rodapié 9x33 cm	3 pcs. / ml	24 pcs. / 14,00 Kg	72 boxes / 1000 Kg	
		Peldaño Fiorentino 33x33x3 cm	3 pcs. / ml	4 pcs. / 12,50 Kg	48 boxes / 610 Kg	
		Cartabón Fiorentino 33x33x3 cm	-	1 pcs. / 4,00 Kg	82 boxes / 340 Kg	
		Zanquín Fiorentino 39,5x17,5 cm	-	14 pcs. / 10,00 Kg	68 boxes	
		Borde Piscina 16x33 cm	3 pcs. / ml	8 pcs. / 22,88 Kg	60 boxes	
		Ángulo exterior 16x16 cm	-	4 pcs. / 4,48 Kg	-	
		Ángulo Interior 20x20 cm	-	4 pcs. / 6,12 Kg	-	
		Malla 33x33 cm	9 pcs. / m ²	-	-	
		URBAN	MEDITERRÁNEO	Base 33x33 cm	9 pcs. / m ²	9 pcs. / 22,20 Kg
Base 33x66,5 cm	4,5 pcs. / m ²			5 pcs. / 25,68 Kg	40 boxes / 1025 Kg	
Rodapié 9x33 cm	3 pcs. / ml			24 pcs. / 14,00 Kg	72 boxes / 1000 Kg	
Vierteaguas 12x33x3 cm	3 pcs. / ml			16 pcs. / 18,00 Kg	50 boxes / 900 Kg	
Peldaño Fiorentino 33x33x3 cm	3 pcs. / ml			4 pcs. / 12,50 Kg	48 boxes / 610 Kg	
Cartabón Fiorentino 33x33x3 cm	-			1 pcs. / 4,00 Kg	82 boxes / 340 Kg	
Zanquín Fiorentino 39,5x17,5 cm	-			14 pcs. / 10,00 Kg	-	
Peldaño Recto 33x33x3 cm	3 pcs. / ml			4 pcs. / 12,50 Kg	48 boxes / 610 Kg	
Zanquín Recto 42,3x17x5 cm	-			14 pcs. / 10,00 Kg	-	
Cenefa 8x33 cm	3 pcs. / ml			9 pcs. / 5,4 Kg	-	
Cenefa 15x33 cm	3 pcs. / ml			6 pcs. / 6,70 Kg	-	
Pasamanos 12,5x24,5x4 cm	4 pcs. / ml			12 pcs. / 15,00 Kg	45 boxes / 680 Kg	
Pasamanos 15x24,5x4 cm	4 pcs. / ml			12 pcs. / 16,50 Kg	39 boxes / 650 Kg	
Pasamanos 21x24,5x,4 cm	4 pcs. / ml			8 pcs. / 14,50 Kg	48 boxes / 705 Kg	
URBAN	LEGEND	Base 33x66,5 cm	4,5 pcs. / m ²	5 pcs. / 25,68 Kg	40 boxes / 1025 Kg	
		Base 33x33 cm	9 pcs. / m ²	9 pcs. / 22,20 Kg	48 boxes / 1070 Kg	
		Rodapié 9x33 cm	3 pcs. / ml	24 pcs. / 14,00 Kg	72 boxes / 1000 Kg	
		Peldaño Fiorentino 33x33x3 cm	3 pcs. / ml	4 pcs. / 12,50 Kg	48 boxes / 610 Kg	
		Cartabón Fiorentino 33x33x3 cm	-	1 pcs. / 4,00 Kg	82 boxes / 340 Kg	
		Zanquín Fiorentino 39,5x17,5 cm	-	14 pcs. / 10,00 Kg	68 boxes	
METAL	METÁLICA	Base 33x33 cm	9 pcs. / m ²	9 pcs. / 22,20 Kg	48 boxes / 1070 Kg	
		Rodapié 9x33 cm	3 pcs. / ml	24 pcs. / 13,90 Kg	72 boxes / 1010 Kg	
		Peldaño Fiorentino 33x33x3 cm	3 pcs. / ml	4 pcs. / 12,70 Kg	48 boxes / 610 Kg	
		Cartabón Fiorentino 33x33x3 cm	-	1 pcs. / 4,00 Kg	82 boxes / 340 Kg	
		Zanquín Fiorentino 39,5x17,5 cm	-	14 pcs. / 10,00 Kg	68 boxes	
		Malla Mureto 28x29 cm	12,3 pcs. / m ²	6 pcs. / 10,20 Kg	-	
	METAL	SILEX	Base 16,25x66,5 cm	9 pcs. / m ²	10 pcs. / 25,60 Kg	40 boxes / 1022 Kg
			Rodapié 9x33 cm	3 pcs. / ml	24 pcs. / 13,90 Kg	72 boxes / 1010 Kg
			Peldaño Fiorentino 33x33x3 cm	3 pcs. / ml	4 pcs. / 12,50 Kg	48 boxes / 610 Kg
			Cartabón Fiorentino 33x33x3 cm	-	1 pcs. / 4,00 Kg	82 boxes / 340 Kg
			Zanquín Fiorentino 39,5x17,5cm	-	14 pcs. / 10,00 Kg	68 boxes
METAL	ÓXIDO	Base 33x33 cm	9 pcs. / m ²	9 pcs. / 22,20 Kg	48 boxes / 1070 Kg	
		Peldaño Fiorentino 33x33x3 cm	3 pcs. / ml	4 pcs. / 12,50 Kg	48 boxes / 610 Kg	
		Cartabón Fiorentino 33x33x3 cm	-	1 pcs. / 4,00 Kg	82 boxes / 340 Kg	

VIERTEAGUAS - WINDOW SILLS - APPUIE DE FENÊTRE

Descripción • Description • Description • Описание

- Forma rectangular con borde lateral redondeado provisto de goterón. Superficie inferior ranurada en cola de milano para optimizar el agarre al soporte.
- Rectangle shape with lateral rounded edge provided with big drop. Back tile in dove tail profile to improve the hold to the stab.
- Format rectangulaire, le bord latérale arrondie avec dispositif anti-goutte. La surface inférieure fendue en queue d'aronde pour optimiser l'adhérence de l'appui.
- Элементы имеют прямоугольную форму с одним закругленным краем для облегчения дренажа. Обратная сторона элементов выполнена в форме сечения "ласточкино хвост" для надежной фиксации элемента.

Aplicaciones y Colocación • Applications and Installation • Applications et pose • Применение и монтаж

- Vierteaguas en ventanas, marquesinas, voladizos, repisas, remate superior de muros medianeros, perimetrales y cercas.
- Window Sills in windows, porches, projecting, brackets, top finishing for diving walls, perimeter walls and fences.
- Appuie pour les fenêtres, marquises, rebords, finition supérieur de murs mitoyens, des clôtures, etc.
- Данная плита укладывается как подоконник, так же подходит для отделки стен, террас, изгородей, а так же наружная облицовка.

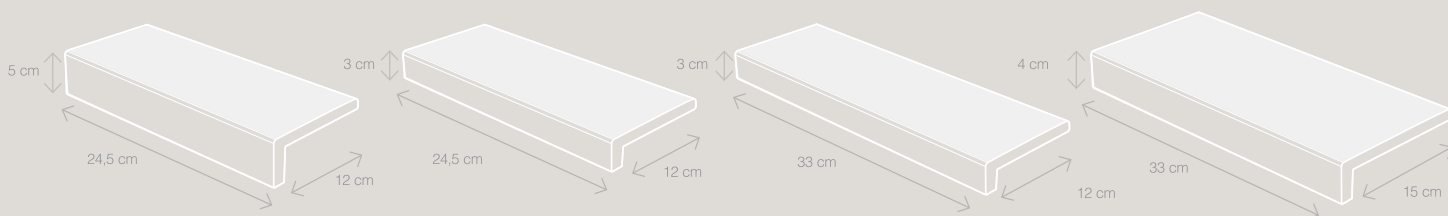

Vierteaguas
12 x 24,5 x 5 cm -
4.8" x 9.8" x 1.97"

Vierteaguas
12 x 24,5 x 3 cm -
4.8" x 9.8" x 1.2"

Vierteaguas
12 x 33 x 3 cm -
4.8" x 13.2" x 1.2"

Vierteaguas
15 x 33 x 4 cm -
5.90" x 13.2" x 1.6"

GAMA DE COLORES / COLOURS RANGE



PASAMANOS - HANDRAILS MAIN COURANT - COUVRE-MURS

Descripción • Description • Description • Описание

- Forma rectangular con bordes laterales redondeados provistos de goterón, la parte superior dispone de una ligera curvatura que facilita el drenaje. Superficie interior ranurada en cola de milano para optimizar el agarre al soporte.
- Rectangle shape with lateral rounded edges provided with big drop, the top side has a slight curvature (bend) to ease the drainage. Back tile in dove tail profile to improve the hold to the stab.
- Format rectangulaire, les bords latéraux arrondis avec dispositif anti-goute, la partie supérieure dispose d'une très légère courbature pour faciliter le drainage. Surface intérieur rainurer pour faciliter la pose sur tous types de support.
- Элементы имеют прямоугольную форму с закругленными краями по углам, верхняя сторона имеет небольшой изгиб для облегчения дренажа. Обратная сторона элементов выполнена в форме сечения "ласточкино хвост" для надежной фиксации элемента.

Aplicaciones y Colocación • Applications and Installation • Applications et pose • Применение и монтаж

- Cubremuros, antepechos de terrazas, azoteas, tendedores, escaleras, pretils y coronación de cercas y muros divisorios.
- Top-wall finishing, terrace parapets, flat roofs, drying places, stairs, handrails and tops for fences and dividing walls.
- Main courante, couvre-murs, finition de murs verticales, etc.
- Используется в качестве поручней и перил лестниц. Может применяется для финишной отделки стен, парапетов террас, плоских крыш, соляриев, верхнего облицовочного элемента стенок, перговонок и т.д.

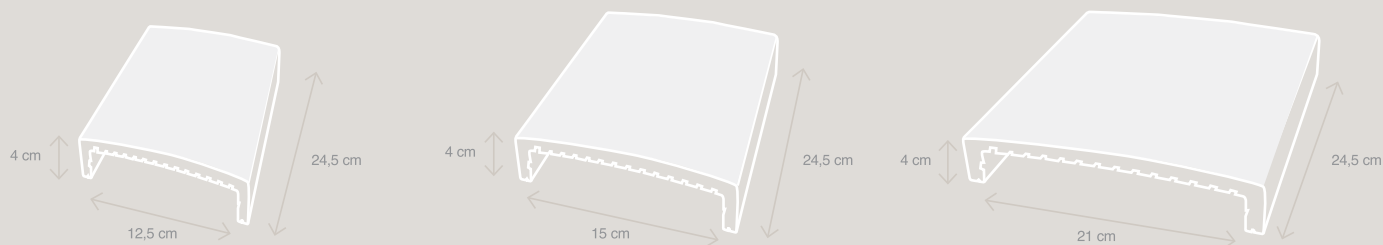

Pasamanos Ref. PAS 12
12,5 x 24,5 x 4 cm -
5" x 9.6" x 1.5"

Pasamanos Ref. PAS 15
15 x 24,5 x 4 cm -
6.2" x 9.6" x 1.5"

Pasamanos Ref. PAS 21
21 x 24,5 x 4 cm -
8.2" x 9.6" x 1.5"

GAMA DE COLORES / COLOURS RANGE



3
PAS 12 - PAS 15 - PAS 21

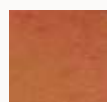

4
PAS 12 - PAS 15 - PAS 21



5
PAS 12 - PAS 15 - PAS 21

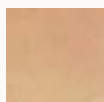

7
PAS 12 - PAS 15 - PAS 21

MEDITERRÁNEO



Arena
PAS 12 - PAS 15 - PAS 21



Grafito
PAS 12 - PAS 15 - PAS 21





COTO TOSCANO



Coto Toscano
PAS 12 - PAS 15

CARACTERÍSTICAS TÉCNICAS / TECHNICAL DATA

- Gres extrusionado de pasta blanca de baja absorción de agua, según ISO UNE-EN 14411, grupo A1, esmaltado en monococción.
- White body extruded stoneware with a low water absorption single fire glazed, according to ISO UNE-EN 14411, group A1.
- Grès étiré de pâte blanche de basse absorption d'eau, selon norme ISO UNE-EN 14411, groupe A1, émaillé en monocuisson.
- Клинкер произведенный из белой глины, способом экструзии с низким водопоглощением по нормам ISO UNE-EN 14411 группа A1. Плитка глазурованная, одинарного обжига.

					
ABSORCIÓN DE AGUA WATER ABSORPTION ABSORPTION D'EAU ВОДОПОГЛОЩЕНИЕ	RESISTENCIA A LA ABRASIÓN (PEI) DEEP ABRASION RESISTANCE RESISTANCE À L'ABRASION СТОЙКОСТЬ К ИСТИРАНИЮ ПОВЕРХНОСТИ	RESISTENCIA AL CUARTEO CRACKING RESISTANCE RESISTANCE AU TRESSAILLAGE УСТОЙЧИВОСТЬ К РАСТРЕСКИВАНИЮ	RESISTENCIA A LA HELADA FROST RESISTANCE RESISTANCE AU GEL МОРОЗОСТОЙКОСТЬ	RESISTENCIA A LOS AGENTES QUÍMICOS CHEMICAL RESISTANCE RESISTANCE AUX PRODUITS CHIMIQUES	RESISTENCIA A LAS MANCHAS STAIN RESISTANCE RESISTANCE AUX TACHES УСТОЙЧИВОСТЬ К ОБРАЗОВАНИЮ ПЯТЕВ
< 1%	PEI - IV	garantizado guaranteed garanti Гарантированно	garantizado guaranteed garanti Гарантированно	A vierteaguas/window sills GA/GLA/GHA pasamanos/handrails	CLASE 5

- Se recomienda utilizar morteros adhesivos de capa fina, tipo cemento-cola de buena calidad, así como un rejuntado impermeable adecuado para uso exterior.
- It is recommended to use thin set mortar and grouting with a waterproof joints grout for outdoors use.
- Nous vous recommandons d'utiliser un mortier adhésif en couche mince du type ciment colle de bonne qualité, ainsi qu'un joint approprié imperméable à l'eau pour une utilisations extérieure.
- Рекомендуется установка на тонкие слой специального монтажного раствора (клея) и применение водоотталкивающих затирок для наружного использования.

PELDAÑO FIORENTINO

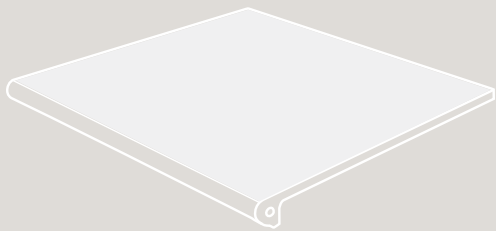

Peldaño Fiorentino
33 x 33 x 3 cm - 13.2" x 13.2" x 1.2"
24,5 x 33 x 3 cm - 9.6" x 13.2" x 1.2"



Cartabón Fiorentino
33 x 33 x 3 cm - 13.2" x 13.2" x 1.2"

ZANQUÍN FIORENTINO



Zanquín Fiorentino Dcha. Izda
39,5 x 17,5 cm - 15.8" x 7"

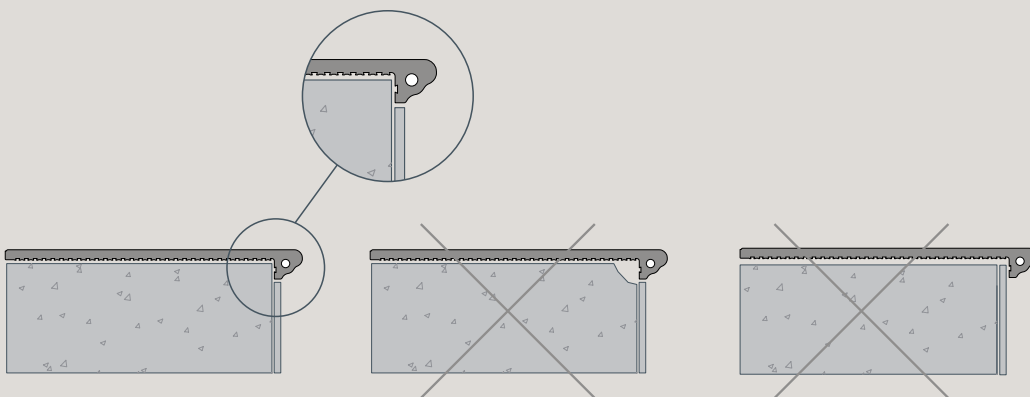

PELDAÑO RECTO



Peldaño Recto
33 x 33 x 3 cm - 13.2" x 13.2" x 1.2"

ZANQUÍN RECTO



Zanquín Recto Dcha. Izda
42,3x 17,5 cm - 16.92" x 7"

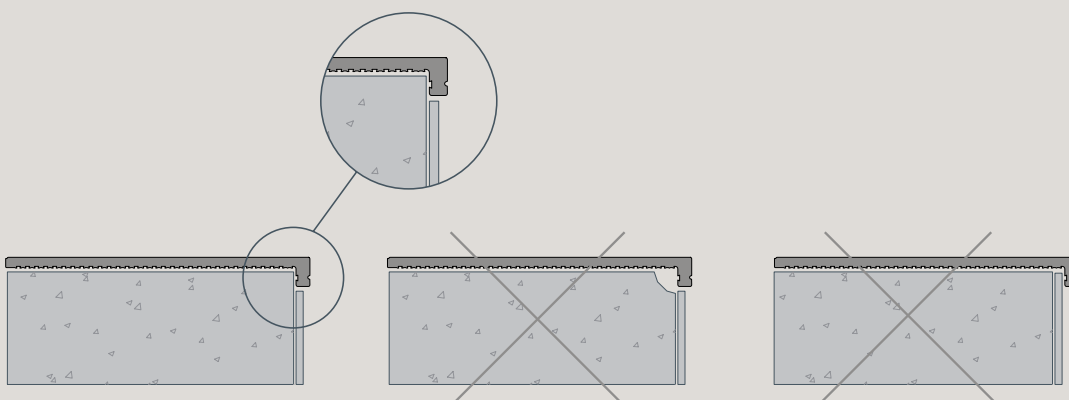

NORMAS DE LIMPIEZA Y MANTENIMIENTO - CLEANING AND MAINTENANCE INDICATIONS DE NETTOYAGE ET DE ENTRETIEN - НОРМЫ ПРАВИЛЬНОЙ ОБРАБОТКИ И ОБСЛУЖИВАНИЯ

LIMPIEZA FINAL DE OBRA • CLEANING AFTER LAYING • NETTOYAGE DE FIN DE CHANTIER • ФИНАЛЬНАЯ ОБРАБОТКА

Después de la colocación es fundamental realizar una buena limpieza para eliminar residuos de junta y en general suciedad de la obra. Para esta operación es aconsejable el empleo de un detergente de acción ligeramente ácida que no despidan humos tóxicos y respete las juntas, el material y el usuario, como Fila Deterdek.

We suggest a good initial cleaning after the laying on the floor or wall, this is very important for removing residual grouting and the normal dirt coming from the building works.

We suggest the use of our product Fila Deterdek, that is a lightly acid product that doesn't emit fumes that are harmful for the user and that can attack joints.

Après la pose est important nettoyer correctement pour éliminer les résidus des joints et en général la saleté de après chantier. Pour bien effectuer cette opération nous conseillons l'utilisation d'un détergent légèrement acide qui n'exhale pas des fumées toxiques et qui respecte les joints, le matériel comme le Deterdek.

После того, как плитка уже выложена, очень важно произвести правильную обработку, чтобы удалить остатки затирки и оставшуюся грязь после работы.

Для этой операции рекомендуется использовать очищающее средство с лёгкой кислотностью, которое не выделяет ядовитых веществ и не разрушает затирку и материал, такое как Fila Deterdek.

MANTENIMIENTO ORDINARIO • REGULAR MAINTENANCE • ENTRETIEN ORDINAIRE • ОБЫЧНОЕ ОБСЛУЖИВАНИЕ

Para un buen mantenimiento del pavimento se aconseja el empleo de un detergente neutro de alto poder limpiador como FilaCleaner.

For a good cleaning of the floor we suggest the use of our product Fila Cleaner it's a natural detergent with a high cleaning power.

Pour un entretien du sol nous vous conseillons l'utilisation de un détergent neutre avec un pouvoir de nettoyage élevé comme le Filacleaner.

Рекомендуется использование нейтрального очищающего средства FilaCleaner, которое имеет высокую способность очищения, не повреждая поверхность и не оставляя остатков.

MANTENIMIENTO EXTRAORDINARIO • EXTRAORDINARY CLEANING • ENTRETIEN EXTRAORDINAIRE

Tipo de suciedad incrustada - Type of dirty Type de saleté - Вид въевшейся грязи	Producto a utilizar - Product to use Produit à utiliser - Чистящие средства
Grasas, bebidas, comidas, goma, tintes, rotulador, etc... • Greasy, drinks, food, tire marks, colours, marker, etc... • Graisse, boissons, nourriture, chewingum, stylo, teintures, etc... • Жир, напитки, еда, краситель, фломастер, итд...	FILA PS/87
Cemento, cal del agua, rayas metales, oxidos • Cement, calcar, metal tracer, rust Ciment, calcaire de l'eau, oxides, saleté métallique •	DETERDEK
Graffiti • Vernis pour le graffiti • Граффити	FILA NOPAINT STAR
Cera de velas, resinas arboles, residuos cinta adhesiva • Wax candel, bitumen, adhesive tape residues Cires de chandelle, résine des arbres, résidues de scotch • Воск, смола из деревьев, остатки клейкой ленты	FILASOLV

Más información / further information:



RECOMENDACIONES DE COLOCACIÓN - INSTALLATION SUGGESTIONS -

RECOMENDACIONES DE COLOCACIÓN

Las Series de EXAGRES, S.A. están fabricadas en gres extrusionado de baja absorción de agua, bajo la norma de producto UNE EN ISO 14411 Grupo A1. Aunque el dorso de las piezas está estriado en cola de milano para aumentar la adhesión de las mismas al mortero de agarre, EXAGRES recomienda, sin excluir otros posibles métodos, la colocación de baldosas y piezas especiales con mortero adhesivo predosificado (tipo cemento-cola) de buena calidad adecuado al uso y condiciones de uso del recubrimiento cerámico.

En zona de climatología severa, riesgo de heladas o colocación en exteriores o piscinas, se recomienda utilizar morteros adhesivos "tipo flexible", "especial porcelánico", "especial fachadas" o "especial piscinas" en cada caso, de un fabricante reconocido de materiales de instalación de cerámica, disponible en almacenes de materiales.

SOPORTE DE COLOCACIÓN

Deberá ser estable dimensionalmente, sano, sólido, resistente y rígido, con superficie de rugosidad suficiente. Soportes flexibles o estructuras deformables requieren una capa de desolidarización y juntas de movimiento, formatos menores y juntas de colocación más anchas.

COLOCACIÓN EN CAPA GRUESA

En caso de utilizar el sistema tradicional, recomendamos usar morteros de capa gruesa mejorados con aditivo látex para aumentar la adhesión de la capa de agarre con la cerámica de baja absorción. Existen morteros adhesivos preparados de capa media que permiten nivelar (hasta 2-3 cm.) e instalar la cerámica a la vez.

COLOCACIÓN EN CAPA FINA

Previamente hay que regularizar el soporte con una capa de mortero de nivelación. Sobre el soporte nivelado se extiende el mortero adhesivo en capa fina (TIPO C2 según norma UNE EN 12004:01), en lecho continuo, con llana dentada de tamaño adecuado. En solados exteriores se resolverán cuidadosamente las pendientes de desagüe, la impermeabilización del soporte y la confección de juntas perimetrales y juntas de partición cada 5x5 m. como máximo. La junta entre las piezas será de 5 mm. para respetar la modularidad de las series y la correspondencia de juntas entre los diferentes formatos y/o piezas especiales.

IMPORTANTE: se respetará la dirección del ranurado posterior de las baldosas, colocándolas siempre en la misma dirección.

REJUNTADO

El rejuntado se efectuará con un material de prestaciones adecuadas a la solicitud del recubrimiento durante su uso, y se optará por un mortero preparado de cualquier fabricante reconocido, ya que ofrecen una amplia gama de colores y materiales de diferentes características. El tipo de mortero de juntas adecuado será Tipo CG2 (según UNE EN 13888) usando, en caso de requerir resistencia química materiales Tipo RG.

ASESORAMIENTO

Es conveniente contar con el asesoramiento del fabricante de materiales de instalación elegido, para que facilite información sobre prestaciones, instrucciones de uso, tiempo abierto, etc. así como procedimientos de limpieza de la instalación después de la colocación y el rejuntado.

TAREAS PREVIAS A LA COLOCACIÓN

Las baldosas se mezclarán antes de su colocación para conseguir una destonificación armónica, abriendo varias cajas de diferentes pallets, en su caso.

LIMPIEZA DE OBRA Y MANTENIMIENTO

Si después de la colocación y la primera limpieza, quedan restos de materiales cementosos sobre la superficie de la instalación, usar un limpiador cerámico o desincrustante ácido adquirido en cualquier almacén de materiales. Antes de la aplicación mojar el recubrimiento para saturar las juntas de agua y protegerlas de la acción del limpiador. Después del lavado, eliminar el producto con abundante agua limpia. Para el mantenimiento ordinario, existen productos adecuados específicos para cerámica.

PAVIMENTOS EXTERIORES

Los pavimentos exteriores se encuentran sometidos continuamente a duras condiciones atmosféricas y a la acción de heladas y choque térmicos, que pueden provocar daños irreparables en la instalación. Por ello se extremará el control de ejecución y la calidad de los materiales empleados.

Se asegurará la estanqueidad de la instalación para evitar filtraciones de agua al soporte y se resolverá cuidadosamente el sellado de las juntas, entre piezas, perimetrales y de dilatación. Las juntas de dilatación y partición atravesarán el solado, la capa de agarre y la de nivelación.

RECLAMACIONES

La legislación actual requiere que las demandas sean presentadas antes de la colocación de las baldosas. De modo que no se considerarán reclamaciones sobre materiales ya colocados.

INSTALLATION SUGGESTIONS

EXAGRES, S.A. Series is a glazed and very low water absorption extruded ceramic, product norm EN ISO 14411 A1 Group. Although the back tiles profiled in dove tail to increase the adherence to the setting mortar, EXAGRES recommend, without excluding any other possible systems, installing the tiles and special pieces with a thin set mortar method.

In outdoor places with a hard cold weather, risk of freeze or when placing in exterior wall, the use of "flexible thin set mortar" is recommended, "special porcelanic tile" or "high strength mortar" from a known manufacturer of ceramic tile installation materials, available in any building materials warehouse or tiles dealer.

INSTALLATION SLAB

Must be clean, dry, structurally sound and ensure the rough surface.

A cleavage membrane is necessary in concrete slabs with a deflection and building structures with a movement. Small sizes tiles, wide joints between tiles and movement joints are recommended.

THICK BED METHOD

In that case, use cement mortars with latex admix, for improved bond to the very low absorption tiles.

You can use medium thickness bed mortars for leveling and installing.

THIN BED METHOD

The installation system, over clean, dry structurally sound and free from any bond breaking surface, consist in placing a thin bond coat (C2 Type EN 12004:01 norm), extended continuously with notched trowel. In exteriors the water draining slopes will be carefully resolved, as well the waterproofing slab and the placing perimeter joints and expansion joints every 5x5 m.

The joint between pieces will be 5 mm. to respect modularity and the correspondance of joints between different sizes and/or specials pieces.

VERY IMPORTANT we recommend setting the pieces with the back grooved in the same direction.

GROUTING

The grouting will be done by a grout that adequates its characteristics to the coating and the use of installation, choosing any grout from any known manufacturer, whose range of colours and materials are usually wider. Grout must be CG2 Type (EN 13888 norm) using grout RG Type (epoxy grout) for best chemical and stain resistance.

TECHNICAL SUPPORT

It is recommended to be advice by the chosen manufacturer in order to be technical supported about characteristics, instructions of use, open time, etc. as well as cleaning tips after installing tiles.

PREVIOUS TASKS BEFORE INSTALLATION

Before laying the tiles, mix them from several boxes and pallets, in order to ensure a uniform look and the best result.

CLEANING AND MAINTENANCE

After the installation and the first cleaning, remove the cured grout with a commercial ceramic cleaner, or acid remover from any ceramic tile installation products manufacturer. Follow the instructions of use from manufacturer. Use specific ceramic cleaners in the maintenance tasks.

EXTERIORS FLOORS

Exterior floors are submitted to several requirements and weather conditions, frost, thermal shocks, etc. which are able to cause damages.

It is essential to check the masonry works, installation method and quality of tiling materials.

Appropriate slopes, waterproofing, expansion and perimeter joints, grouting and sealing the joints, are fundamental.

COMPLAINTS

Note that current legislation requires disputes to be before installation tiles. Complaints concerning already laid materials shall not, therefore, be proposed and shall not be considered.

RECOMMANDATIONS POUR LA POSE - РЕКОМЕНДАЦИИ ПО УКЛАДКЕ КЕРАМИЧЕСКО Й ПЛИТКИ И СПЕЦИАЛЬНЫХ ЭЛЕМЕНТОВ EXAGRES

RECOMMANDATIONS POUR LA POSE

Les séries d'EXAGRES S.A. ont été fabriquées en gres étiré. Ce carreaux ont une absorption d'eau basse selon la norme UNE EN ISO 14411 Groupe A1. Bien que la queue d'aronde du dos des carreaux serve à mieux les adhérer au mortier, Exagres conseille de placer les carreaux et pièces spéciales à l'aide d'un mortier adhésif prédosé (genre ciment-colle) de bonne qualité et approprié aux possibles domaines d'application des carreaux.

SUPPORT

Le support doit être solide, résistant, rigide et suffisamment rugueux. Les supports souples ou les structures déformables ont besoin d'une couche de désolidaritation; des joints de mouvement, des formats plus petits, ainsi que des joints plus larges.

POSE EN COUCHE ÉPAISSE

En ce qui concerne le système traditionnel, nous recommandons l'utilisation de mortiers à couche épaisse améliorés à base d'additif latex afin d'augmenter l'adhésion de la couche d'adhérence avec la céramique à absorption basse. Il existe des mortiers adhésifs à couche moyenne déjà préparés qui permettent de niveler (jusqu'à 2-3 cm) et installer les carreaux au même temps.

POSE EN COUCHE MINCE

Premièrement il faut régulariser le support à l'aide d'une couche de mortier de nivellement. Sur le support nivelé il faut étendre le mortier adhésif en couche mince (TYPE C2 selon UNE EN 12004 :01) et continueuse avec une truelle dentée. Quant aux surfaces extérieures il faut faire attention aux pentes de drainage, à l'imperméabilisation du support. Nous recommandons faire des joints de dilatation tous les 5x5 m au maximum. Les joints entre les carreaux doivent avoir une largeur de 5 mm afin de respecter la modularité des différentes séries.

ATTENTION: il est conseillé de poser les carreaux de façon à ce que la queue d'aronde suive toujours la même direction.

JOINTOLEMENT

Il est conseillé d'effectuer le jointolement avec du matériel approprié au domaine possible d'application des carreaux, en choisissant un mortier d'un fabricant spécialisé, puisqu'ils offrent un grand choix de couleurs et matériaux. Le mortier pour joints le plus approprié est celui de Type CG2 (selon UNE EN 13888). Nous recommandons le matériel du Type RG pour obtenir une résistance aux produits chimiques complémentaire.

SUGGESTION: Il est recommandable de se faire conseiller par le fabricant du matériel choisi par rapport aux caractéristiques, mode d'emploi, temps d'ouverture. Également il peut vous conseiller sur le nettoyage du sol après la pose des carreaux.

RECOMMANDATIONS AVANT LA POSE

Pour que la surface totale de carrelage ait une détonification harmonique, nous conseillons de mélanger des carreaux de différentes boîtes.

NETTOYAGE ET ENTRETIEN

Dans le cas où il resterait des traits de mortier sur la surface d'installation, il faudrait utiliser un produit spécifique pour la céramique ou, autrement, un produit désincrustant. Premièrement il est conseillé de mouiller la surface à nettoyer avec l'objectif de remplir les joints d'eau et les protéger de l'action du produit nettoyant. Une fois le nettoyant appliqué, il faut rincer avec d'eau propre. Pour ce qui concerne l'entretien ordinaire, il existe des produits spécifiques pour la céramique.

REVÊTEMENTS À L'EXTÉRIEUR

Les carreaux posés à l'extérieur peuvent souffrir les effets des chocs thermiques, des gelées, etc, ce qui peut endommager l'installation. De ce fait il faut absolument faire attention aux travaux de pose du carrelage, ainsi qu'à la qualité des matériaux utilisés. Il faut éviter les filtrations d'eau dans le support. Il faut également faire attention à bien sceller tous les joints.

RÉCLAMATIONS

Selon la loi actuelle aucune réclamation ne sera prise en compte après la pose des carreaux céramiques. Une fois les carreaux placés, les réclamations ne seront pas prises en compte.

РЕКОМЕНДАЦИИ ПО УКЛАДКЕ КЕРАМИЧЕСКО Й ПЛИТКИ И СПЕЦИАЛЬНЫХ ЭЛЕМЕНТОВ EXAGRES

Все коллекции фабрики EXAGRES, S.A. произведены по технологии экструдированного клинкера. Керамическая плитка и элементы EXAGRES имеют низкое водопоглощение в соответствии с нормативом UNE EN ISO 14411 Группа A1.

ОБЩИЕ РЕКОМЕНДАЦИИ

Технология подготовки оснований и укладки керамической плитки, а также специальных элементов должна соответствовать строительным правилам и нормам вашего региона. При использовании материалов необходимо тщательно следовать рекомендациям и правилам применения Производителей данных материалов

НАПОЛЬНАЯ ПЛИТКА ДЛЯ НАРУЖНОГО ПРИМЕНЕНИЯ

Внешние покрытия всегда подвергаются воздействию погодных условий, мороза, перепадов температуры, что может послужить причиной деформации укладки. Поэтому, рекомендуем Вам контролировать процесс укладки и качество используемых материалов и растворов.

Основание должно быть должным образом усилено арматурой и гидроизолировано, чтобы избежать протечек воды.

Рекомендуется хорошо заполнять швы между плитками, компенсационные швы и швы по периметру, примыкающие к стенам здания. Компенсационные швы должны полностью пересекать все основание.

ОСНОВАНИЕ, НА КОТОРУЮ БУДЕТ УКЛАДЫВАТЬСЯ ПЛИТКА

Основание, на которую будет укладываться плитка должна быть идеально ровное, прочное, устойчивое и твердое. Поверхность основания должна быть достаточно шероховатой.

При необходимости, при наружных работах, основание должно быть гидроизолировано. Плитка и ступени на наружных площадках и лестницах должны быть уложены под определенным углом, для избегания застаивания воды

КЛЕЕВЫЕ СМЕСИ

EXAGRES рекомендует, укладывать облицовочную плитку с использованием качественных клеевых цементных смесей, отвечающим требованиям эксплуатации плитки.

Для укладки плитки в бассейнах, в местах с контрастным климатом, а также при наружных работах, рекомендуется использовать профессиональные клеевые смеси, пригодные для реальных условий эксплуатации, например:

- специальный для наружных работ
- специальный для керамогранита
- специальный для фасадов
- специальный для бассейнов
- специальный для клинкера

Клеевые смеси, которые будут использоваться для укладки плитки EXAGRES, должны быть пригодны для приклейки плитки с низким коэффициентом водопоглощения, согласно рекомендациям производителя клеевой смеси

УКЛАДКА В ТОЛСТОМ СЛОЕ

При укладке плитки с одновременным выравниванием основания, а также при толщине плиточного клея до 2-3 см, рекомендуется специальный клей для толстого слоя с латексными добавками.

УКЛАДКА В ТОНКОМ СЛОЕ

Прежде чем наносить слой клея, требуется выровнять основание. Клеевая смесь наносится зубчатым шпателем на ровное основание тонким слоем

УКЛАДКА ПЛИТКИ

EXAGRES рекомендует перед укладкой плитки и ступеней, вынуть ее из всех коробок и тщательно перемешать между собой, для того чтобы достичь гармоничной разнотонности.

Укладка плитки осуществляется по направлению полос, которые находятся на задней стороне плитки и элементов

КОМПЕНСАЦИОННЫЙ ШОВ РАСШИРЕНИЯ

При укладке плитки на подвижные основания, которые могут деформироваться в процессе эксплуатации требуется предусмотреть компенсационный шов расширения между рядами плитки. Компенсационный шов расширения рекомендуется делать каждые 5x5 м, а также в местах примыкания площадок к стенам зданий. Ширина шва должна быть не меньше 5 мм. Шов расширения должен быть заполнен эластичным наполнителем.

ЗАТИРКА

Затирочный раствор для швов, выбирается в зависимости от условий дальнейшей эксплуатации настиленной поверхности. При укладке снаружи затирка может быть сделана влагостойкой с помощью специальных добавок.

ОКОНЧАТЕЛЬНАЯ ЧИСТКА И УХОД

После укладки плитки для удаления цементного налета рекомендуется использовать специальное средство для снятия налета, которые имеются у поставщиков клеевой смеси.

Перед использованием средства для удаления налета необходимо намочить швы водой, для того, чтобы их защитить.

После очистки требуется окончательно смыть средство водой из шланга или аппарата высокого давления

Для регулярной чистки рекомендуется использование подходящего для керамики средства.

ÍNDICE POR FORMATOS - FORMATS INDEX - FORMATS - Форматы

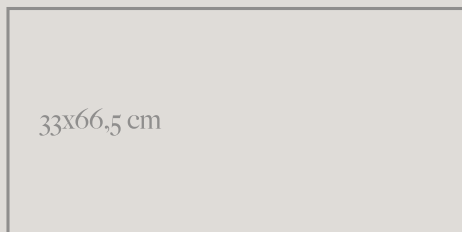

LEGEND	52-55
MEDITERRÁNEO	56-59
PROJECTKER	60-63
TAIGA	14-17



ALHAMAR	20-29
LEGEND	52-55
MEDITERRÁNEO	56-59
METÁLICA	66-69
ÓXIDO	70-73
PROJECTKER	60-63
PETRA	40-45
VEGA	46-49

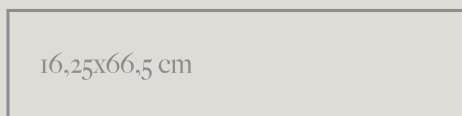

NATURA	06-13
SILEX	72-75
TAIGA	14-17

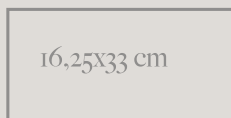

ALHAMAR	20-29
PROJECTKER	60-63



ATLAS	36-39
COTO TOSCANO	30-33

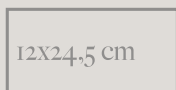

COTO TOSCANO	30-33
ATLAS	36-39

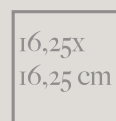

ALHAMAR	20-29
PROJECTKER	60-63



exagres

by versatile

Avda. Reina de los Apóstoles s/n
12549 Betxí (Castellón de la Plana) Spain
tel. (+34) 964 623 250
fax nacional (+34) 964 621 166
fax ventas (+34) 964 622 309
info@versatile.es
nacional@versatile.es
exportacion@versatile.es
ofitec@versatile.es
www.versatile.es

